

Appearance Kit - RED

PRODUCT INFORMATION

Description	Appearance Kit - RED
Product Weight	0.40 lbs / 0.18 kgs
Shipping Weight	0.40 lbs / 0.18 kgs

TRAIL 6 FLASH.

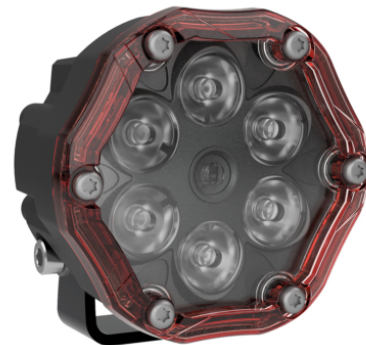

TRAIL 6 FLASH.

PRODUCT DIMENSIONS

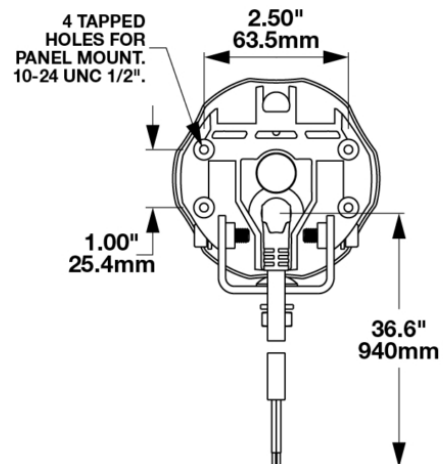
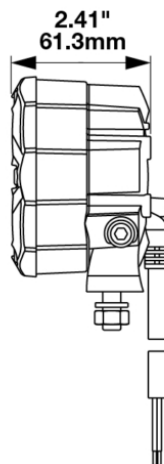
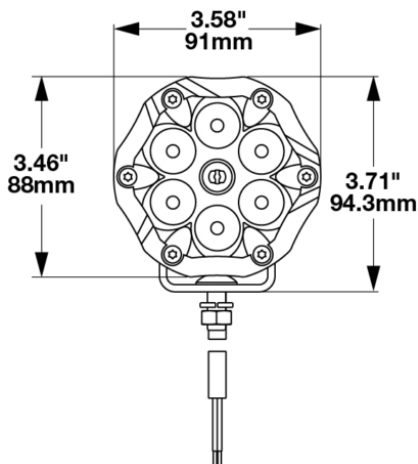

Print date: 2026-05-12

© 2026 J.W. Speaker Corporation • Germantown, WI U.S.A.
www.jwspeaker.com • speaker@jwspeaker.com • 262.251.6660

Appearance Kit - RED

REGULATORY STANDARDS COMPLIANCE



Buy America Standards



Eco Friendly

APPLICATIONS



PRODUCT WARNINGS

For California residents:

⚠ WARNING: Cancer and reproductive harm - www.P65Warnings.ca.gov.

⚠ AVERTISSEMENT: Cancer et effet nocif sur la reproduction - www.P65Warnings.ca.gov.

SUITS THESE PRODUCTS

TRAIL 6 FLASH



3.7" Round LED Off Road Warning Lights

Round LED Off Road Warning Light - Model Trail 6 Flash

TRAIL 6 SPORT



3.7" Round LED Off Road Lights

Round LED Off Road Lights - Model Trail 6 Sport

Print date: 2026-05-12

© 2026 J.W. Speaker Corporation • Germantown, WI U.S.A.
www.jwspeaker.com • speaker@jwspeaker.com • 262.251.6660