

# Model 8700 EVO-X Headlight

## PRODUCT INFORMATION

---

<b>Description</b>	12-24V DOT LED RHT High and Low Beam Heated Headlight with Chrome Bezel
<b>Height</b>	177.20 mm / 6.98 in
<b>Width</b>	177.20 mm / 6.98 in
<b>Depth</b>	84.35 mm / 3.32 in
<b>Shape</b>	Round
<b>Outer Lens Material</b>	Hardcoated Polycarbonate
<b>Outer Lens Color</b>	Clear
<b>Housing Material</b>	Polycarbonate
<b>Housing Color</b>	Black
<b>Bezel Color</b>	Chrome
<b>Retrofits</b>	2D1 "PAR56" or 7" Round Headlights
<b>Minimum Operating Temperature</b>	-40 °C / -40 °F
<b>Maximum Operating Temperature</b>	65 °C / 149 °F
<b>Connector or Wiring</b>	Integrated 6-pin Deutsch to H4 (AMP #172615-2), 10" length
<b>Mating Connector</b>	H4 AMP#172615-2

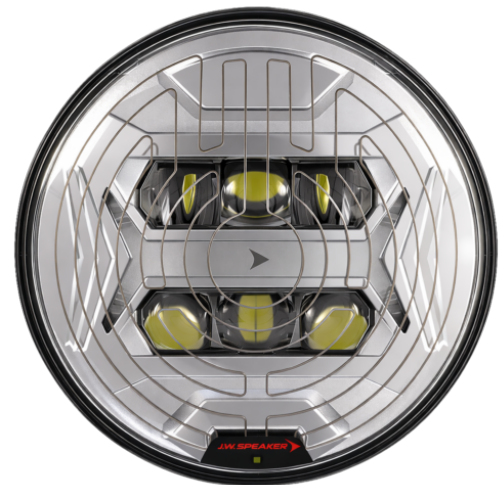

---

**Print date: 2026-07-09**

© 2026 J.W. Speaker Corporation • Germantown, WI U.S.A.  
www.jwspeaker.com • speaker@jwspeaker.com • 262.251.6660

**J.W. SPEAKER**   
Engineered. Lighting. Solutions.

# Model 8700 EVO-X Headlight

## PRODUCT DIMENSIONS

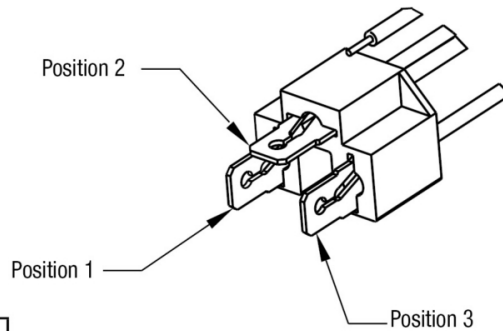
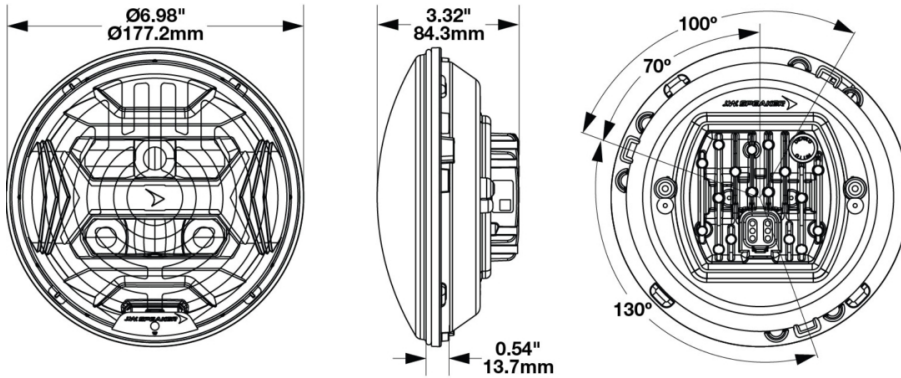

PIN	WIRE
1	Red
2	Not Used
3	Black

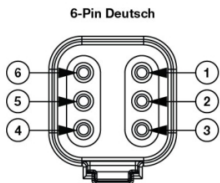

PIN	FUNCTION
PIN 1	Ground
PIN 2	Low Beam
PIN 3	High Beam
PIN 4	-
PIN 5	-
PIN 6	-

Print date: 2026-07-09

© 2026 J.W. Speaker Corporation • Germantown, WI U.S.A.  
[www.jwspeaker.com](http://www.jwspeaker.com) • [speaker@jwspeaker.com](mailto:speaker@jwspeaker.com) • 262.251.6660

# Model 8700 EVO-X Headlight

## ELECTRICAL SPECIFICATIONS

---

<b>Input Voltage</b>	12-24V DC
<b>Operating Voltage</b>	9-32V DC
<b>Yellow Wire</b>	Low Beam
<b>White Wire</b>	High Beam
<b>Black Wire</b>	Ground
<b>Current Draw</b>	5.29A @ 12V DC (Low Beam) 4.33A @ 24V DC (Low Beam) 7.72A @ 12V DC (High Beam) 5.41A @ 24V DC (High Beam)

## REGULATORY STANDARDS COMPLIANCE

---



FMVSS 108 s10.1 (Table XIX)	FMVSS 108 s10.1 (Table XVIII)
IEC IP67	IEC IP69K
SAE J1383	

**Print date: 2026-07-09**

© 2026 J.W. Speaker Corporation • Germantown, WI U.S.A.  
www.jwspeaker.com • speaker@jwspeaker.com • 262.251.6660

**J.W. SPEAKER**   
Engineered. Lighting. Solutions.

# Model 8700 EVO-X Headlight

## PHOTOMETRIC SPECIFICATIONS

<b>Raw Lumen Output</b>	3,740 (High beam), 2,330 (Low Beam)
<b>Effective Lumen Output</b>	1,310 (High Beam), 690 (Low beam)
<b>Candela Output</b>	57,700
<b>Nominal LED Color Temperature</b>	5700 K
<b>Beam Pattern(s)</b>	Forward Lighting - High Beam (DOT) Forward Lighting - Low Beam (DOT)

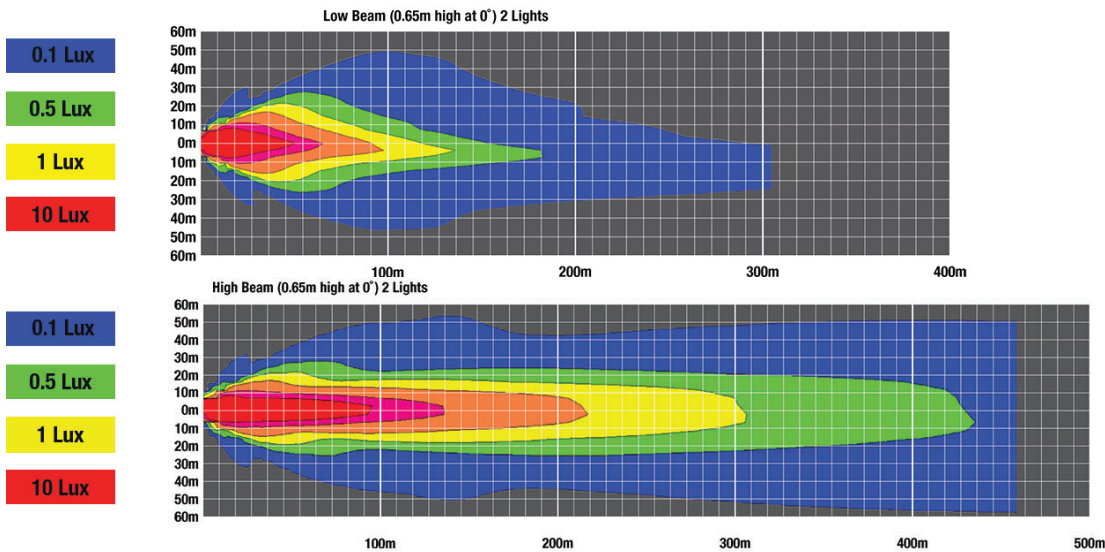

## APPLICATIONS



Print date: 2026-07-09

© 2026 J.W. Speaker Corporation • Germantown, WI U.S.A.  
 www.jwspeaker.com • speaker@jwspeaker.com • 262.251.6660

# Model 8700 EVO-X Headlight

## PRODUCT WARNINGS

---

For California residents:

⚠ **WARNING:** Cancer and reproductive harm - [www.P65Warnings.ca.gov](http://www.P65Warnings.ca.gov).

⚠ **AVERTISSEMENT:** Cancer et effet nocif sur la reproduction - [www.P65Warnings.ca.gov](http://www.P65Warnings.ca.gov).

## ACCESSORIES

---



**Part Number**  
**3272541**  
High Beam/Low Beam  
and Front Position H4  
Harness



**Part Number**  
**3272551**  
High Beam and Low  
Beam H4 Harness



**Part Number**  
**3272681**  
5-in-1 Flying Lead  
Harness

# Model 8700 EVO-X Headlight

## RELATED PRODUCTS

---



**Part Number**  
**0562231**  
12-24V DOT/ECE LED  
RHT 5-in-1 Headlight  
with Black Bezel



**Part Number**  
**0562241**  
12-24V DOT/ECE LED  
RHT 5-in-1 Headlight  
with Chrome Bezel



**Part Number**  
**0562251**  
12-24V DOT/ECE LED  
RHT 5-in-1 Heated  
Headlight with Black  
Bezel

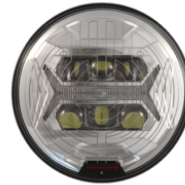

**Part Number**  
**0562261**  
12-24V DOT/ECE LED  
RHT 5-in-1 Heated  
Headlight with Chrome  
Bezel

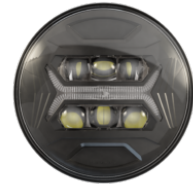

**Part Number**  
**0562271**  
12-24V DOT/ECE LED  
High and Symmetric  
Low Beam Headlight  
with Front Position  
with Black Bezel

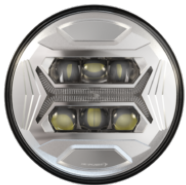

**Part Number**  
**0562281**  
12-24V DOT/ECE LED  
High and Symmetric  
Low Beam Headlight  
with Front Position  
with Chrome Bezel

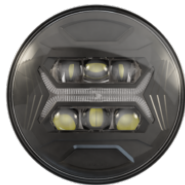

**Part Number**  
**0562291**  
12-24V ECE LED LHT  
5-in-1 Headlight with  
Black Bezel

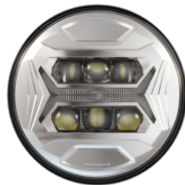

**Part Number**  
**0562301**  
12-24V ECE LED LHT  
5-in-1 Headlight with  
Chrome Bezel