

Model 8700 EVO-X Headlight

PRODUCT INFORMATION

Description	12-24V DOT LED RHT High and Low Beam Heated Headlight with Black Bezel
Height	177.20 mm / 6.98 in
Width	177.20 mm / 6.98 in
Depth	84.35 mm / 3.32 in
Shape	Round
Outer Lens Material	Hardcoated Polycarbonate
Outer Lens Color	Clear
Housing Material	Polycarbonate
Housing Color	Black
Bezel Color	Black
Retrofits	2D1 "PAR56" or 7" Round Headlights
Minimum Operating Temperature	-40 °C / -40 °F
Maximum Operating Temperature	65 °C / 149 °F
Connector or Wiring	Integrated 6-pin Deutsch to H4 (AMP #172615-2), 10" length
Mating Connector	H4 AMP#172615-2



Print date: 2026-04-29

© 2026 J.W. Speaker Corporation • Germantown, WI U.S.A.
www.jwspeaker.com • speaker@jwspeaker.com • 262.251.6660

J.W. SPEAKER 
Engineered. Lighting. Solutions.

Model 8700 EVO-X Headlight

PRODUCT DIMENSIONS

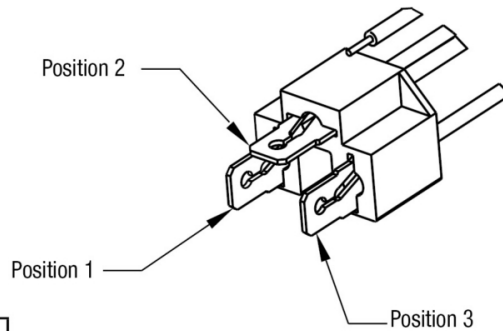
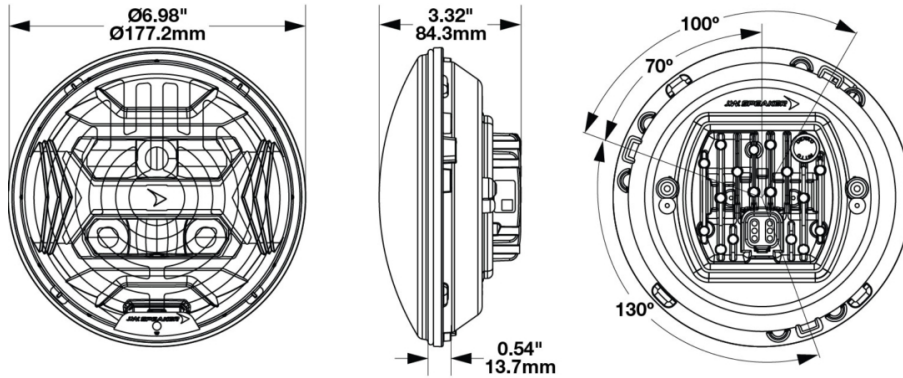

PIN	WIRE
1	Red
2	Not Used
3	Black

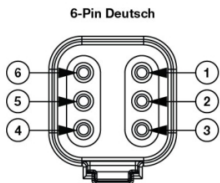

PIN	FUNCTION
PIN 1	Ground
PIN 2	Low Beam
PIN 3	High Beam
PIN 4	-
PIN 5	-
PIN 6	-

Print date: 2026-04-29

© 2026 J.W. Speaker Corporation • Germantown, WI U.S.A.
www.jwspeaker.com • speaker@jwspeaker.com • 262.251.6660

Model 8700 EVO-X Headlight

ELECTRICAL SPECIFICATIONS

Input Voltage	12-24V DC
Operating Voltage	9-32V DC
Yellow Wire	Low Beam
White Wire	High Beam
Black Wire	Ground
Current Draw	5.29A @ 12V DC (Low Beam) 4.33A @ 24V DC (Low Beam) 7.72A @ 12V DC (High Beam) 5.41A @ 24V DC (High Beam)

REGULATORY STANDARDS COMPLIANCE



FMVSS 108 s10.1 (Table XIX)	FMVSS 108 s10.1 (Table XVIII)
IEC IP67	IEC IP69K
SAE J1383	

Print date: 2026-04-29

© 2026 J.W. Speaker Corporation • Germantown, WI U.S.A.
www.jwspeaker.com • speaker@jwspeaker.com • 262.251.6660

J.W. SPEAKER 
Engineered. Lighting. Solutions.

Model 8700 EVO-X Headlight

PHOTOMETRIC SPECIFICATIONS

Raw Lumen Output	3,740 (High beam), 2,330 (Low Beam)
Effective Lumen Output	1,310 (High Beam), 690 (Low beam)
Candela Output	57,700
Nominal LED Color Temperature	5700 K
Beam Pattern(s)	Forward Lighting - High Beam (DOT) Forward Lighting - Low Beam (DOT)

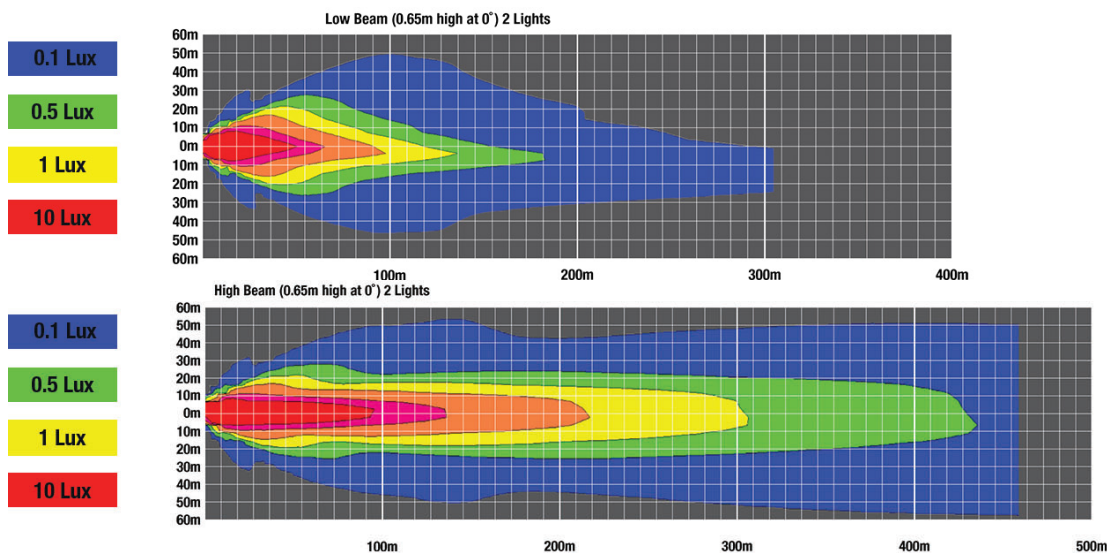

APPLICATIONS



PRODUCT WARNINGS

For California residents:

⚠️ **WARNING:** Cancer and reproductive harm - www.P65Warnings.ca.gov.

⚠️ **AVERTISSEMENT:** Cancer et effet nocif sur la reproduction - www.P65Warnings.ca.gov.

Print date: 2026-04-29

© 2026 J.W. Speaker Corporation • Germantown, WI U.S.A.
www.jwspeaker.com • speaker@jwspeaker.com • 262.251.6660

J.W. SPEAKER
 Engineered. Lighting. Solutions.

Model 8700 EVO-X Headlight

RELATED PRODUCTS



Part Number
0562231
12-24V DOT/ECE LED
RHT 5-in-1 Headlight
with Black Bezel

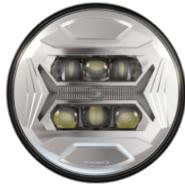

Part Number
0562241
12-24V DOT/ECE LED
RHT 5-in-1 Headlight
with Chrome Bezel



Part Number
0562251
12-24V DOT/ECE LED
RHT 5-in-1 Heated
Headlight with Black
Bezel

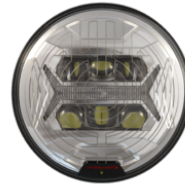

Part Number
0562261
12-24V DOT/ECE LED
RHT 5-in-1 Heated
Headlight with Chrome
Bezel

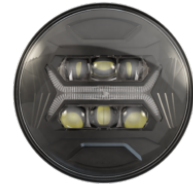

Part Number
0562271
12-24V DOT/ECE LED
High and Symmetric
Low Beam Headlight
with Front Position
with Black Bezel

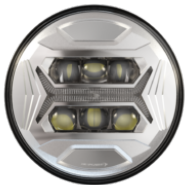

Part Number
0562281
12-24V DOT/ECE LED
High and Symmetric
Low Beam Headlight
with Front Position
with Chrome Bezel

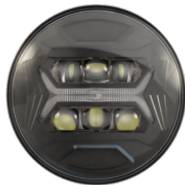

Part Number
0562291
12-24V ECE LED LHT
5-in-1 Headlight with
Black Bezel

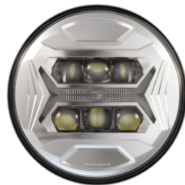

Part Number
0562301
12-24V ECE LED LHT
5-in-1 Headlight with
Chrome Bezel