

Model 8700 EVO-X Headlight

PRODUCT INFORMATION

Description	12-24V ECE LED LHT 5-in-1 Headlight with Chrome Bezel
Height	177.20 mm / 6.98 in
Width	177.20 mm / 6.98 in
Depth	84.35 mm / 3.32 in
Shape	Round
Outer Lens Material	Hardcoated Polycarbonate
Outer Lens Color	Clear
Housing Material	Polycarbonate
Housing Color	Black
Bezel Color	Chrome
Retrofits	2D1 "PAR56" or 7" Round Headlights
Minimum Operating Temperature	-40 °C / -40 °F
Maximum Operating Temperature	65 °C / 149 °F
Connector or Wiring	integrated 6-pin Deutsch
Mating Connector	Deutsch DT06-6S



Print date: 2026-04-17

© 2026 J.W. Speaker Corporation • Germantown, WI U.S.A.
www.jwspeaker.com • speaker@jwspeaker.com • 262.251.6660

Model 8700 EVO-X Headlight

PRODUCT DIMENSIONS

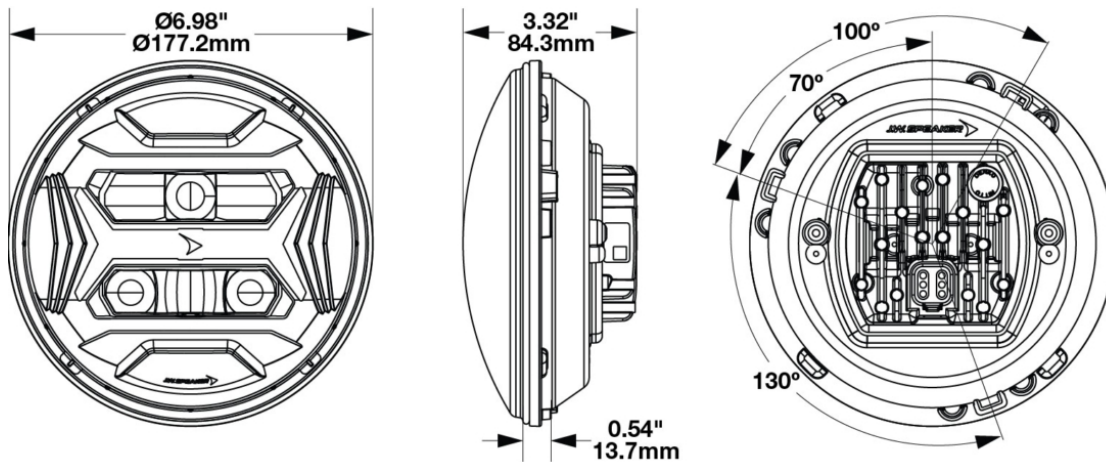

View: Back of Lamp
6-Pin Deutsch



PIN	FUNCTION
PIN 1	Front Position
PIN 2	Daytime Running Light
PIN 3	Direction Indicator*
PIN 4	Ground
PIN 5	Low Beam
PIN 6	High Beam

Note: Reference number on Deutsch Connector
*Direction Indicator (DI) is not DOT compliant

Print date: 2026-04-17

© 2026 J.W. Speaker Corporation • Germantown, WI U.S.A.
www.jwspeaker.com • speaker@jwspeaker.com • 262.251.6660

Model 8700 EVO-X Headlight

ELECTRICAL SPECIFICATIONS

Input Voltage	12-24V DC
Operating Voltage	9-32V DC
Current Draw	2.09A @ 12V DC (Low Beam) 1.13A @ 24V DC (Low Beam) 4.52A @ 12V DC (High Beam) 2.21A @ 24V DC (High Beam) 0.26A @ 12V DC (Front Position) 0.15A @ 24V DC (Front Position) 2.52A @ 12V DC (DRL) 1.28A @ 24V DC (DRL) 2.95A @ 12V DC (Direction Indicator) 1.53A @ 24V DC (Direction Indicator)

REGULATORY STANDARDS COMPLIANCE



ECE Reg 10
ECE Reg 148 - A
ECE Reg 149 - C
IEC IP67



ECE Reg 148 - 1b
ECE Reg 148 - RL
ECE Reg 149 - HR
IEC IP69K

Print date: 2026-04-17

© 2026 J.W. Speaker Corporation • Germantown, WI U.S.A.
www.jwspeaker.com • speaker@jwspeaker.com • 262.251.6660

Model 8700 EVO-X Headlight

PHOTOMETRIC SPECIFICATIONS

Raw Lumen Output	3,740 (High beam), 2,330 (Low Beam)
Effective Lumen Output	1,455 (High Beam), 765 (Low beam)
Nominal LED Color Temperature	5700 K
Beam Pattern(s)	Forward Lighting - Daytime Running Light Forward Lighting - High Beam (ECE) Forward Lighting - Low Beam (ECE Left Hand) Signalization - Front Position Signalization - Turn (Front)

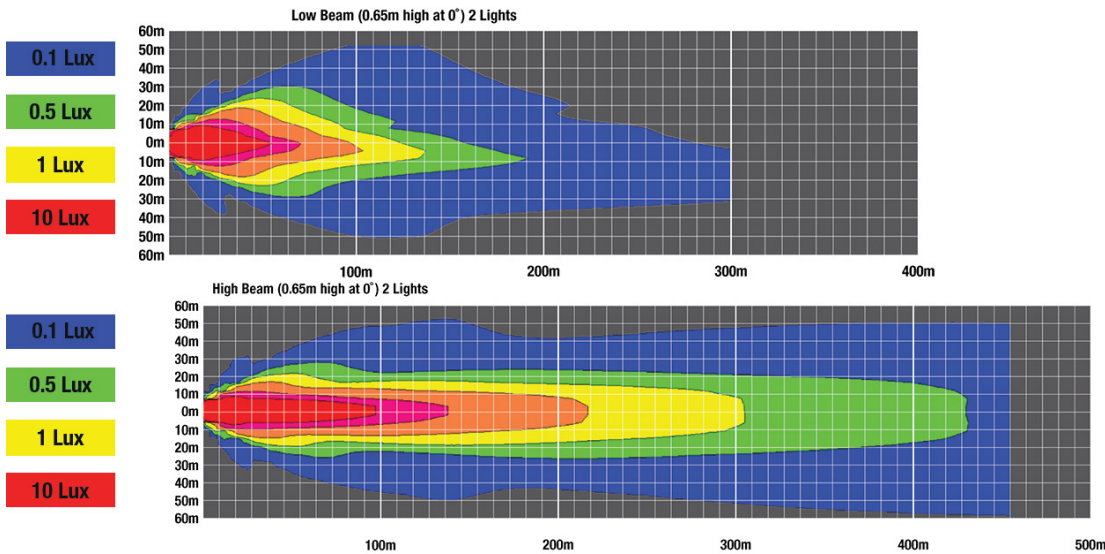

APPLICATIONS



Print date: 2026-04-17

© 2026 J.W. Speaker Corporation • Germantown, WI U.S.A.
www.jwspeaker.com • speaker@jwspeaker.com • 262.251.6660

Model 8700 EVO-X Headlight

PRODUCT WARNINGS

For California residents:

⚠ **WARNING:** Cancer and reproductive harm - www.P65Warnings.ca.gov.

⚠ **AVERTISSEMENT:** Cancer et effet nocif sur la reproduction - www.P65Warnings.ca.gov.

RELATED PRODUCTS



Part Number
0562231

12-24V DOT/ECE LED
RHT 5-in-1 Headlight
with Black Bezel

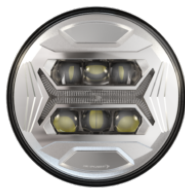

Part Number
0562241

12-24V DOT/ECE LED
RHT 5-in-1 Headlight
with Chrome Bezel



Part Number
0562251

12-24V DOT/ECE LED
RHT 5-in-1 Heated
Headlight with Black
Bezel

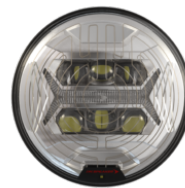

Part Number
0562261

12-24V DOT/ECE LED
RHT 5-in-1 Heated
Headlight with Chrome
Bezel

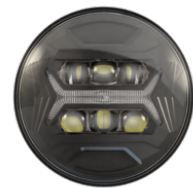

Part Number
0562271

12-24V DOT/ECE LED
High and Symmetric
Low Beam Headlight
with Front Position
with Black Bezel



Part Number
0562281

12-24V DOT/ECE LED
High and Symmetric
Low Beam Headlight
with Front Position
with Chrome Bezel

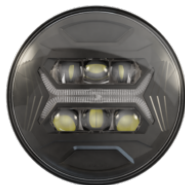

Part Number
0562291

12-24V ECE LED LHT
5-in-1 Headlight with
Black Bezel

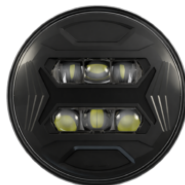

Part Number
0562331

12-24V DOT LED RHT
High and Low Beam
Headlight with Black
Bezel

Print date: 2026-04-17

© 2026 J.W. Speaker Corporation • Germantown, WI U.S.A.
www.jwspeaker.com • speaker@jwspeaker.com • 262.251.6660