

LED Front Position & Signal Lights – Model 215

PRODUCT INFORMATION

Description	12V SAE LED Stop, Tail & Turn Light - 2 Light Kit
Height	36.00 mm / 1.42 in
Width	124.00 mm / 4.88 in
Depth	25.50 mm / 1 in
Shape	Rectangular
Outer Lens Color	Clear
Housing Material	Polycarbonate
Housing Color	Black
Mounting Hardware Description	(x4) Palnut SD250095, 1*4" Self-Threading Nut
Mating Connector	Deutsch DT06-3S-P012
Product Weight	0.33 lbs / 0.15 kgs
Shipping Weight	0.37 lbs / 0.17 kgs

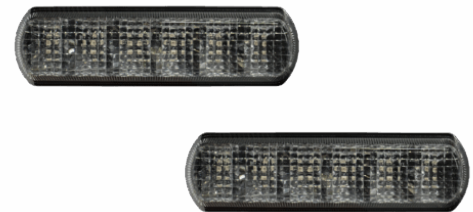

Print date: 2026-05-09

© 2026 J.W. Speaker Corporation • Germantown, WI U.S.A.
www.jwspeaker.com • speaker@jwspeaker.com • 262.251.6660

J.W. SPEAKER 
Engineered. Lighting. Solutions.

LED Front Position & Signal Lights - Model 215

PRODUCT DIMENSIONS

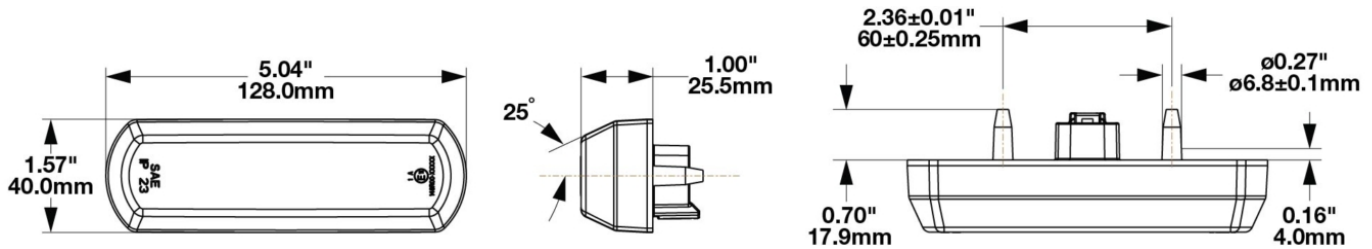

PIN	FUNCTION
PIN A	STOP
PIN B	TAIL
PIN C	GROUND

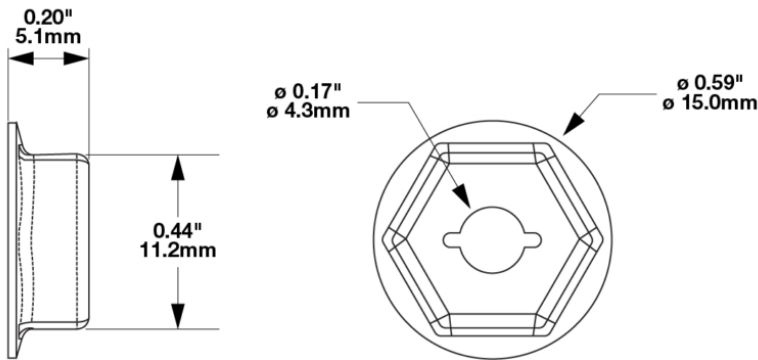
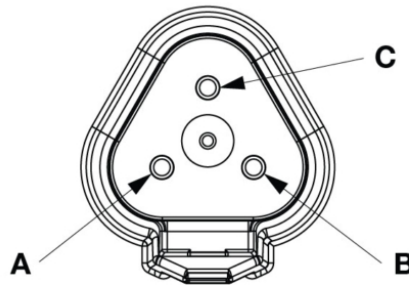

5430452
(Not Included)

ELECTRICAL SPECIFICATIONS

Input Voltage	12V DC
Operating Voltage	9-16V DC
Current Draw	.285A @ 13.5V DC (Stop) .033A @ 13.5V DC (Tail)

Print date: 2026-05-09

© 2026 J.W. Speaker Corporation • Germantown, WI U.S.A.
www.jwspeaker.com • speaker@jwspeaker.com • 262.251.6660

LED Front Position & Signal Lights – Model 215

REGULATORY STANDARDS COMPLIANCE



FMVSS 108 s7.1 (Table XIII) FMVSS 108 s7.2 (Table VIII)
IEC IP69K SAE J131
SAE J586

PHOTOMETRIC SPECIFICATIONS

Beam Pattern(s) Signalization - Stop
 Signalization - Tail

APPLICATIONS



PRODUCT WARNINGS

For California residents:

⚠️ **WARNING:** Cancer and reproductive harm - www.P65Warnings.ca.gov.

⚠️ **AVERTISSEMENT:** Cancer et effet nocif sur la reproduction - www.P65Warnings.ca.gov.

Print date: 2026-05-09

© 2026 J.W. Speaker Corporation • Germantown, WI U.S.A.
www.jwspeaker.com • speaker@jwspeaker.com • 262.251.6660

LED Front Position & Signal Lights - Model 215

ACCESSORIES



Part Number
3270601

Wire Harness, 12"
18GA w/ DT06-3S

RELATED PRODUCTS



Part Number
0348251

12V ECE/SAE LED
Front Position &
Direction Indicator
Light



Part Number
0348252

12V ECE/SAE LED
Front Position &
Direction Indicator
Light (BULK)



Part Number
0348451

24V ECE LED Front
Position & Direction
Indicator Light



Part Number
0348452

24V ECE LED Front
Position & Direction
Indicator Light (BULK)



Part Number
0348733

12V ECE/SAE LED
Direction Indicator - 2
Light Kit



Part Number
0348743

12V ECE LED Stop,
Tail, & Turn - 2 Light
Kit

Print date: 2026-05-09

© 2026 J.W. Speaker Corporation • Germantown, WI U.S.A.
www.jwspeaker.com • speaker@jwspeaker.com • 262.251.6660