

LED Signal Lights – Military Blackout Lights

PRODUCT INFORMATION

Description	24V 40mm Amber Front Blackout Marker Light - Bulk Qty (18 MIN)
Height	39.88 mm / 1.57 in
Width	59.94 mm / 2.36 in
Depth	45.72 mm / 1.8 in
Shape	Round
Outer Lens Material	Polycarbonate
Outer Lens Color	Clear
Housing Material	Nylon
Housing Color	Black
Mounting Hardware Description	(x2) #6-Screw
Mounting Type	Flange Mount
Minimum Operating Temperature	-40 °C / -40 °F
Maximum Operating Temperature	85 °C / 185 °F
Connector or Wiring	Deutsch DT04-2P
Mating Connector	Deutsch DT06-2S
Product Weight	0.08 lbs / 0.04 kgs
Shipping Weight	2.20 lbs / 1 kgs
Additional Information	Light color is Amber. Meets MIL-PRF-32214 Section 3.8.5



Print date: 2026-05-15

© 2026 J.W. Speaker Corporation • Germantown, WI U.S.A.
 www.jwspeaker.com • speaker@jwspeaker.com • 262.251.6660

LED Signal Lights - Military Blackout Lights

PRODUCT DIMENSIONS

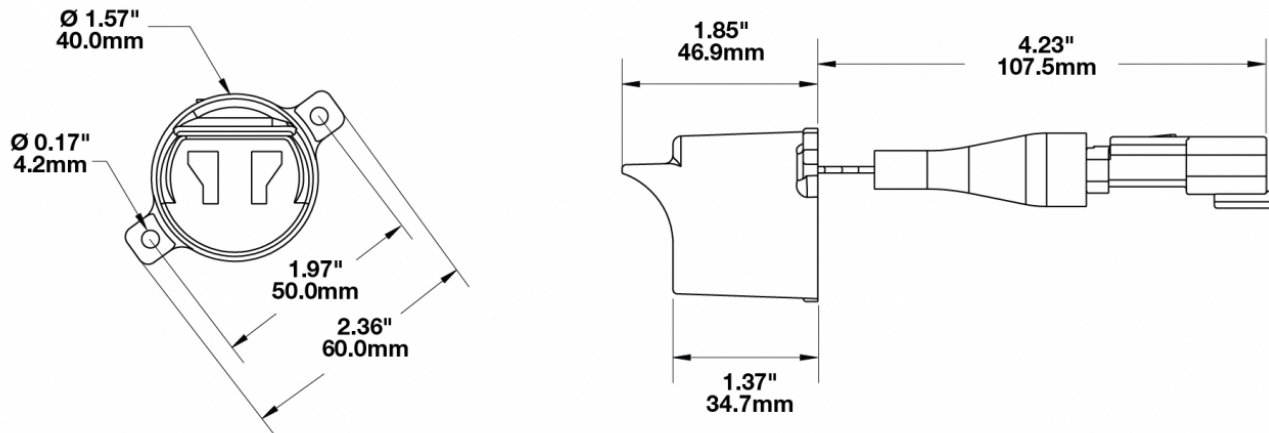

ELECTRICAL SPECIFICATIONS

Input Voltage	24V DC
Operating Voltage	18-32V DC
Black Wire	Ground
Red Wire	Positive
Current Draw	0.025A @ 24V DC

REGULATORY STANDARDS COMPLIANCE



Buy America Standards
IEC IP67

Eco Friendly

PHOTOMETRIC SPECIFICATIONS

Beam Pattern(s) Signalization - Marker

Print date: 2026-05-15

© 2026 J.W. Speaker Corporation • Germantown, WI U.S.A.
www.jwspeaker.com • speaker@jwspeaker.com • 262.251.6660

J.W. SPEAKER
Engineered. Lighting. Solutions.

LED Signal Lights - Military Blackout Lights

APPLICATIONS



PRODUCT WARNINGS

For California residents:

⚠ **WARNING:** Cancer and reproductive harm - www.P65Warnings.ca.gov.

⚠ **AVERTISSEMENT:** Cancer et effet nocif sur la reproduction - www.P65Warnings.ca.gov.

RELATED PRODUCTS



Part Number
0347512
24V 40mm Red Rear
Blackout Tail Light -
Bulk Qty (18 MIN)



Part Number
0347522
24V 40mm Amber
Rear Blackout Stop
Light - Bulk Qty (18
MIN)



Part Number
0550312
24V 40mm Cyan LH
Blackout Driving Light
- Bulk Qty (18 MIN)



Part Number
0550732
24V 40mm Cyan RH
Blackout Driving Light
- Bulk Qty (18 MIN)



Part Number
0556132
12-24V 117mm Cyan
Blackout Driving Light
with Tan Housing -
Bulk Qty (24 MIN)



Part Number
0556142
12-24V 117mm Cyan
Blackout Driving Light
with Green Housing -
Bulk Qty (24 MIN)

Print date: 2026-05-15

© 2026 J.W. Speaker Corporation • Germantown, WI U.S.A.
www.jwspeaker.com • speaker@jwspeaker.com • 262.251.6660

J.W. SPEAKER
Engineered. Lighting. Solutions.