

LED Work Lights - Model 770 XD

PRODUCT INFORMATION

Description	12-48V LED Work Light with Spot Beam Pattern & DT04-2P Connector
Height	137.16 mm / 5.4 in
Width	144.02 mm / 5.67 in
Depth	56.90 mm / 2.24 in
Shape	Oval
Outer Lens Material	Polycarbonate
Outer Lens Color	Clear
Housing Material	Polycarbonate
Housing Color	Black
Mounting Hardware Description	(x1) 5/16"-18 x 1.25" Mounting Bolt
Mounting Type	Universal Pedestal Mount
Minimum Operating Temperature	-40 °C / -40 °F
Maximum Operating Temperature	65 °C / 149 °F
Connector or Wiring	Integrated 2-Pin Deutsch Weather-Proof Socket (DT04-2P)
Mating Connector	2-Pin Deutsch Weather-Proof Plug (DT06-2S)
Product Weight	0.86 lbs / 0.39 kgs
Shipping Weight	0.54 lbs / 0.24 kgs



Print date: 2026-06-13

© 2026 J.W. Speaker Corporation • Germantown, WI U.S.A.
www.jwspeaker.com • speaker@jwspeaker.com • 262.251.6660

J.W. SPEAKER 
Engineered. Lighting. Solutions.

LED Work Lights - Model 770 XD

PRODUCT DIMENSIONS

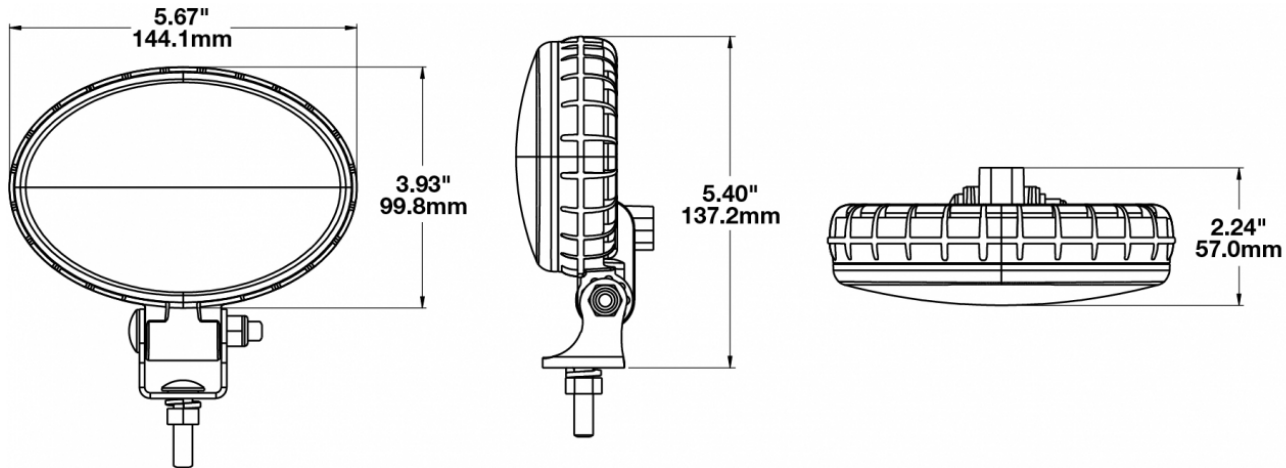

ELECTRICAL SPECIFICATIONS

Input Voltage	12-48V DC
Operating Voltage	10-55V DC
Transient Spike Protection	330V Peak @ 1 HZ-100 Pulses
Red Wire	Positive
Black Wire	Negative
Current Draw	1A @ 12V DC 0.48A @ 24V DC 0.32A @ 36V DC 0.25A @ 48V DC

Print date: 2026-06-13

© 2026 J.W. Speaker Corporation • Germantown, WI U.S.A.
www.jwspeaker.com • speaker@jwspeaker.com • 262.251.6660

LED Work Lights - Model 770 XD

REGULATORY STANDARDS COMPLIANCE



Buy America Standards	CISPR 12
CISPR 22	Eco Friendly
IEC IP67	SAE J1113-13
UL Recognized	

PHOTOMETRIC SPECIFICATIONS

Raw Lumen Output	900
Effective Lumen Output	700
Nominal LED Color Temperature	5000 K
Beam Pattern(s)	Forward Lighting - Spot

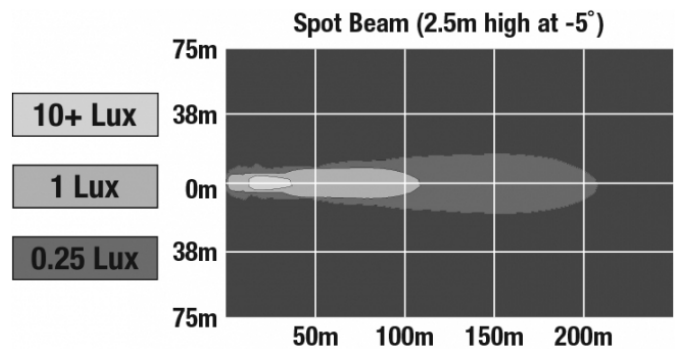

APPLICATIONS



Print date: 2026-06-13

© 2026 J.W. Speaker Corporation • Germantown, WI U.S.A.
 www.jwspeaker.com • speaker@jwspeaker.com • 262.251.6660

LED Work Lights - Model 770 XD

PRODUCT WARNINGS

For California residents:

⚠ **WARNING:** Cancer and reproductive harm - www.P65Warnings.ca.gov.

⚠ **AVERTISSEMENT:** Cancer et effet nocif sur la reproduction - www.P65Warnings.ca.gov.

RELATED PRODUCTS



Part Number
1706041

12V LED Work Light
with Flood Beam
Pattern & DT04-2P
Connector



Part Number
1706051

12V LED Work Light
with Trapezoid Beam
Pattern & DT04-2P
Connector



Part Number
1706241

12-48V LED Work Light
with Flood Beam
Pattern & DT04-2P
Connector



Part Number
1706251

12-48V LED Work Light
with Trapezoid Beam
Pattern & DT04-2P
Connector



Part Number
1706461

12-48V LED Work Light
with Flood Beam
Pattern & PE12015792
Connector