

LED Work Lights - Model 660

PRODUCT INFORMATION

Description	12-24V LED Work Light with Flood Beam Pattern & Pedestal Mount
Height	121.92 mm / 4.8 in
Width	169.93 mm / 6.69 in
Depth	81.53 mm / 3.21 in
Shape	Oval
Outer Lens Material	Glass
Outer Lens Color	Clear
Housing Material	Die-Cast Aluminum
Housing Color	Black
Mounting Hardware Description	(x1) M8-1.25 x 20mm Mounting Bolt
Mounting Type	Universal Pedestal Mount
Minimum Operating Temperature	-40 °C / -40 °F
Maximum Operating Temperature	65 °C / 149 °F
Mating Connector	Packard (#12059183)
Product Weight	1.53 lbs / 0.69 kgs
Shipping Weight	2.69 lbs / 1.22 kgs



PRODUCT DIMENSIONS

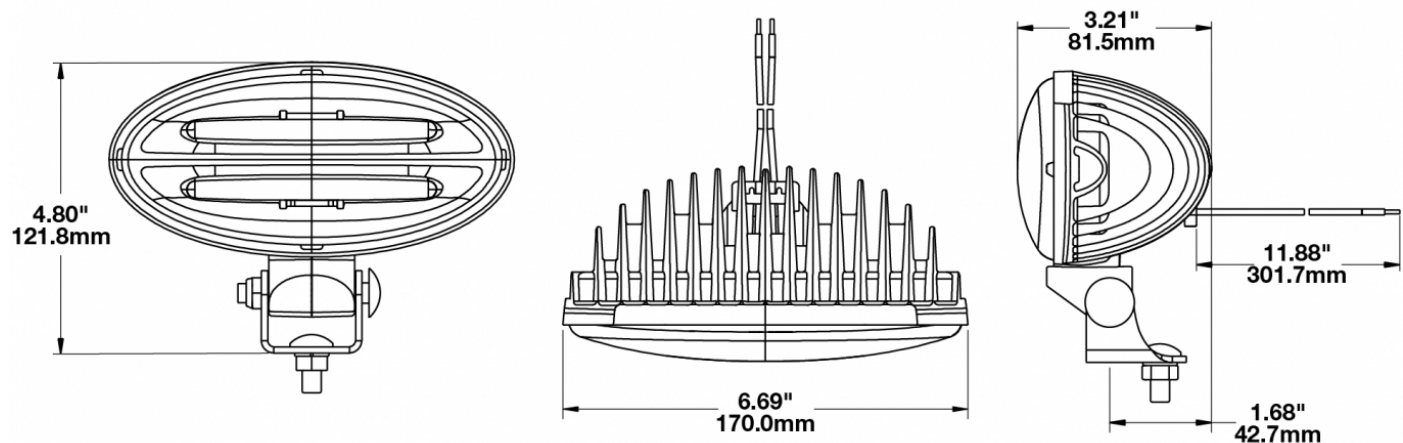

Print date: 2026-05-06

© 2026 J.W. Speaker Corporation • Germantown, WI U.S.A.
 www.jwspeaker.com • speaker@jwspeaker.com • 262.251.6660

J.W. SPEAKER
 Engineered. Lighting. Solutions.

LED Work Lights - Model 660

ELECTRICAL SPECIFICATIONS

Input Voltage	12-24V DC
Operating Voltage	9-28V DC
Transient Spike Protection	150V Peak @ 1 HZ-100 Pulses
Red Wire	Positive
Black Wire	Negative
Current Draw	2.0A @ 12V DC 1.0A @ 24V DC

REGULATORY STANDARDS COMPLIANCE



Buy America Standards
IEC IP69K

Eco Friendly

PHOTOMETRIC SPECIFICATIONS

Raw Lumen Output	2,750
Effective Lumen Output	2,200
Nominal LED Color Temperature	5000 K
Beam Pattern(s)	Forward Lighting - Flood (Standard)

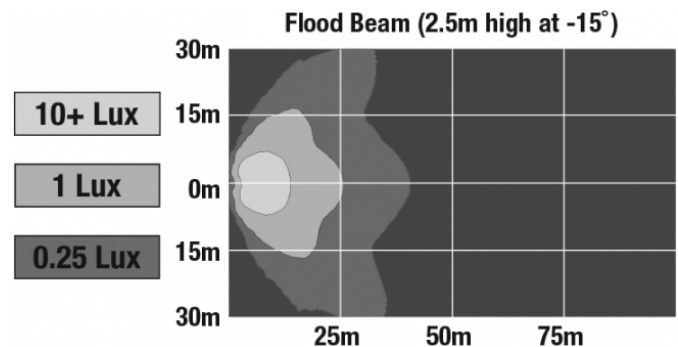

Print date: 2026-05-06

© 2026 J.W. Speaker Corporation • Germantown, WI U.S.A.
www.jwspeaker.com • speaker@jwspeaker.com • 262.251.6660

LED Work Lights - Model 660

APPLICATIONS



PRODUCT WARNINGS

For California residents:

⚠ **WARNING:** Cancer and reproductive harm - www.P65Warnings.ca.gov.

⚠ **AVERTISSEMENT:** Cancer et effet nocif sur la reproduction - www.P65Warnings.ca.gov.

RELATED PRODUCTS



Part Number

0548521

12-24V LED Work Light
with Flood Beam
Pattern & Panel Mount