

LED Work Light - Model 526

PRODUCT INFORMATION

Description	24V LED Work Light with Yellow Housing, Polycarbonate Lens & Dual White Anti-Glare Pattern
Height	160.47 mm / 6.32 in
Width	158.00 mm / 6.22 in
Depth	98.00 mm / 3.86 in
Shape	Square
Outer Lens Material	Polycarbonate
Outer Lens Color	Clear
Housing Material	Die-Cast Aluminum
Housing Color	Yellow
Mounting Hardware Description	(x1) M10-1.5 x 40mm Mounting Bolt
Mounting Type	Universal Pedestal Mount
Minimum Operating Temperature	-40 °C / -40 °F
Maximum Operating Temperature	65 °C / 149 °F
Connector or Wiring	iCONN connector - IMate23 3 wire
Product Weight	4.60 lbs / 2.09 kgs
Shipping Weight	4.88 lbs / 2.21 kgs
Additional Information	Warm/Cool White Color Temperatures: Warm White: 2800K Cool White: 5000K



Print date: 2026-06-13

© 2026 J.W. Speaker Corporation • Germantown, WI U.S.A.
www.jwspeaker.com • speaker@jwspeaker.com • 262.251.6660

J.W. SPEAKER 
Engineered. Lighting. Solutions.

LED Work Light - Model 526

PRODUCT DIMENSIONS

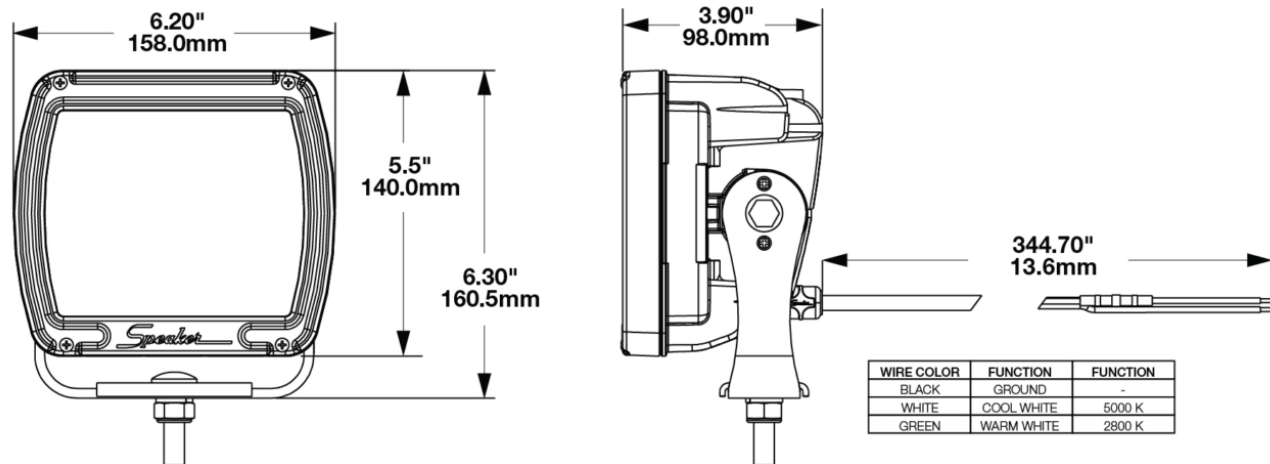

ELECTRICAL SPECIFICATIONS

Input Voltage	24V DC
Operating Voltage	16-32V DC
Transient Spike Protection	330V Peak @ 1 HZ-100 Pulses
White Wire	Cool White
Black Wire	Ground
Green Wire	Warm White
Current Draw	3.25A @ 24V DC (Warm White) 3.25A @ 24V DC (Cool White)

REGULATORY STANDARDS COMPLIANCE



IEC IP69K

Print date: 2026-06-13

© 2026 J.W. Speaker Corporation • Germantown, WI U.S.A.
www.jwspeaker.com • speaker@jwspeaker.com • 262.251.6660

J.W. SPEAKER
Engineered. Lighting. Solutions.

LED Work Light - Model 526

PHOTOMETRIC SPECIFICATIONS

Raw Lumen Output	(warm) 7500, (cool) 9900
Effective Lumen Output	(warm) 3390, (cool) 3464
Candela Output	(warm) 4508, (cool) 4488
Beam Pattern(s)	Forward Lighting - Dual Beam

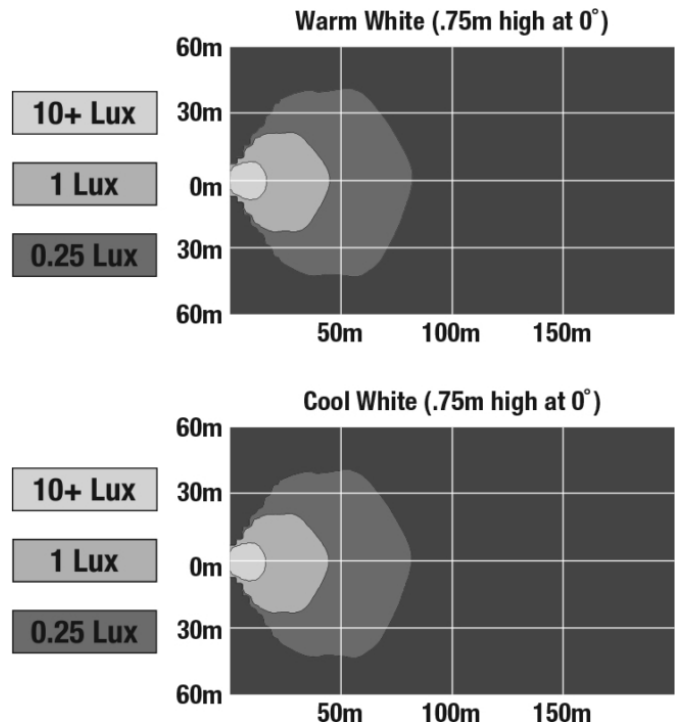

APPLICATIONS



Print date: 2026-06-13

© 2026 J.W. Speaker Corporation • Germantown, WI U.S.A.
 www.jwspeaker.com • speaker@jwspeaker.com • 262.251.6660

LED Work Light - Model 526

PRODUCT WARNINGS

For California residents:

⚠ **WARNING:** Cancer and reproductive harm - www.P65Warnings.ca.gov.

⚠ **AVERTISSEMENT:** Cancer et effet nocif sur la reproduction - www.P65Warnings.ca.gov.

ACCESSORIES



Part Number

3267541

12" 18AWG iCONN
iMATE 23 Wire Asm
w/DT04-2P



Part Number

3268191

15M 18AWG iCONN
iMATE 23 Wire Asm
w/DT04-2P



Part Number

3268201

2.5M 18AWG iCONN
iMATE 23 Wire Asm
w/DT04-2P

LED Work Light - Model 526

RELATED PRODUCTS



Part Number
1300581
24V LED Work Light
with Black Housing,
Polycarbonate Lens &
Flood Beam Pattern



Part Number
1300591
24V LED Work Light
with Black Housing,
Polycarbonate Lens &
Trapezoid Beam
Pattern



Part Number
1300601
24V Anti-Glare Beam
Pattern w/
Polycarbonate Lens



Part Number
1300641
24V LED Work Light
with Black Housing,
Polycarbonate Lens &
Dual White Anti-Glare
Pattern



Part Number
1300711
24V LED Work Light
with Black Housing,
Polycarbonate Lens &
Spot Beam Pattern



Part Number
1300721
12V LED Work Light
with Black Housing,
Polycarbonate Lens &
Flood Beam Pattern



Part Number
1300741
12V LED Work Light
with Black Housing,
Polycarbonate Lens &
Anti-Glare Pattern



Part Number
1300751
12V LED Work Light
with Yellow Housing,
Polycarbonate Lens &
Dual White Anti-Glare
Pattern