

LED Work Light - Model 4417

PRODUCT INFORMATION

Description	12/24V LED Work Light Pedestal Mount
Height	108.00 mm / 4.25 in
Width	85.00 mm / 3.35 in
Depth	42.00 mm / 1.65 in
Shape	Round
Outer Lens Material	Polycarbonate
Outer Lens Color	Clear
Housing Material	Aluminum
Housing Color	Black
Mounting Hardware Description	(x1) 8mm-20 x 25mm Mounting Bolt Bracket
Mounting Type	Pedestal
Minimum Operating Temperature	-40 °C / -40 °F
Maximum Operating Temperature	65 °C / 149 °F
Mating Connector	Deutsch DT06-2S-E003
Product Weight	1.40 lbs / 0.64 kgs
Shipping Weight	1.75 lbs / 0.79 kgs



PRODUCT DIMENSIONS

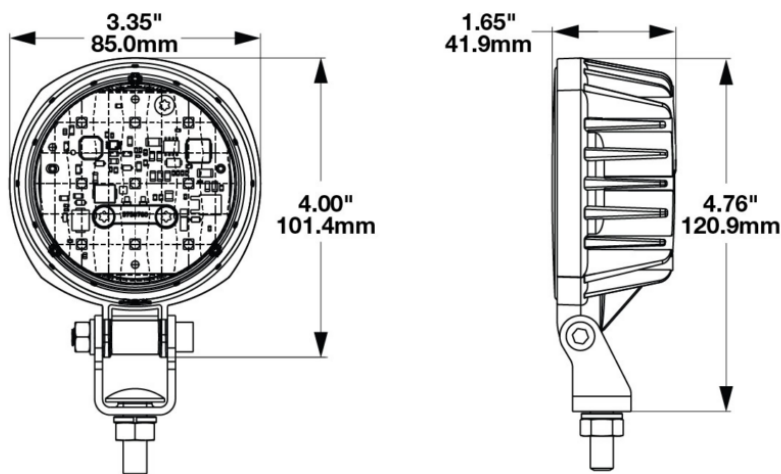

Print date: 2026-05-09

© 2026 J.W. Speaker Corporation • Germantown, WI U.S.A.
www.jwspeaker.com • speaker@jwspeaker.com • 262.251.6660

J.W. SPEAKER
Engineered. Lighting. Solutions.

LED Work Light - Model 4417

ELECTRICAL SPECIFICATIONS

Input Voltage	12-24V DC
Operating Voltage	9-32V DC
Red Wire	Power
Black Wire	Ground
Current Draw	2.75A @ 12V DC (Power) 1.3A @ 24V DC (Power)

REGULATORY STANDARDS COMPLIANCE



CE Recognized
IEC IP69K

IEC IP67

PHOTOMETRIC SPECIFICATIONS

Raw Lumen Output	4375
Effective Lumen Output	2265
Candela Output	3000
Nominal LED Color Temperature	5050 K
Beam Pattern(s)	Forward Lighting - Flood (Standard)

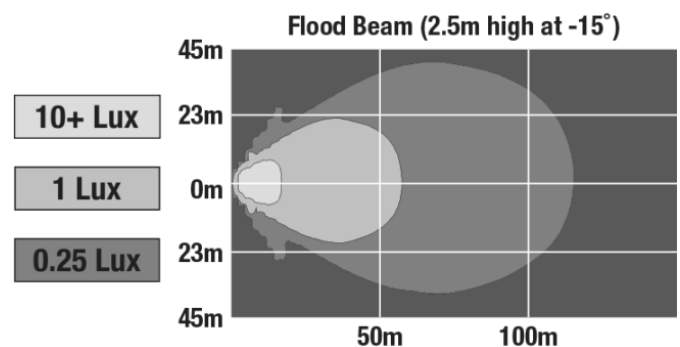

Print date: 2026-05-09

© 2026 J.W. Speaker Corporation • Germantown, WI U.S.A.
www.jwspeaker.com • speaker@jwspeaker.com • 262.251.6660

LED Work Light - Model 4417

APPLICATIONS



PRODUCT WARNINGS

For California residents:

⚠ **WARNING:** Cancer and reproductive harm - www.P65Warnings.ca.gov.

⚠ **AVERTISSEMENT:** Cancer et effet nocif sur la reproduction - www.P65Warnings.ca.gov.

ACCESSORIES



Part Number

8201241

DIN Pole Mount for
Work Lights

Print date: 2026-05-09

© 2026 J.W. Speaker Corporation • Germantown, WI U.S.A.
www.jwspeaker.com • speaker@jwspeaker.com • 262.251.6660