

# Mounting Kit for Model 279 - 2 Light Kit

## PRODUCT INFORMATION

<b>Description</b>	Mounting Kit for Model 279 - 2 Light Kit
<b>Height</b>	205.00 mm / 8.07 in
<b>Width</b>	150.00 mm / 5.91 in
<b>Depth</b>	25.40 mm / 1 in
<b>Shape</b>	Rectangular
<b>Housing Color</b>	Black
<b>Mounting Hardware Description</b>	(x4) 40-.25 x Mounting Screws
<b>Mounting Type</b>	Universal Mount
<b>Shipping Weight</b>	2.95 lbs / 1.34 kgs
<b>Additional Information</b>	Kit includes (2) mounting brackets and (4) screws to mount bracket to Model 279 tail light. Use existing hardware to mount bracket to vehicle.

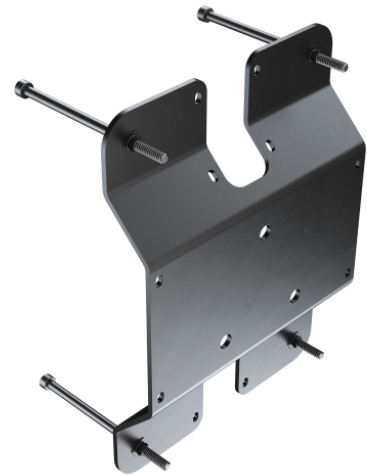

## PRODUCT DIMENSIONS

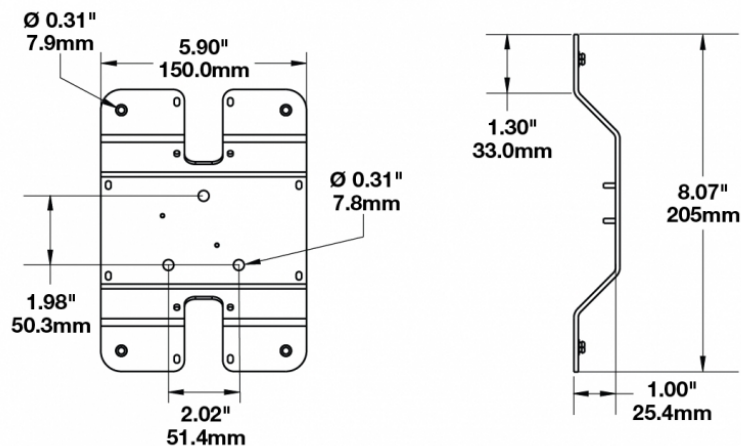

Print date: 2026-04-03

© 2026 J.W. Speaker Corporation • Germantown, WI U.S.A.  
[www.jwspeaker.com](http://www.jwspeaker.com) • [speaker@jwspeaker.com](mailto:speaker@jwspeaker.com) • 262.251.6660

# Mounting Kit for Model 279 - 2 Light Kit

## REGULATORY STANDARDS COMPLIANCE

---



Buy America Standards

Eco Friendly

## APPLICATIONS

---

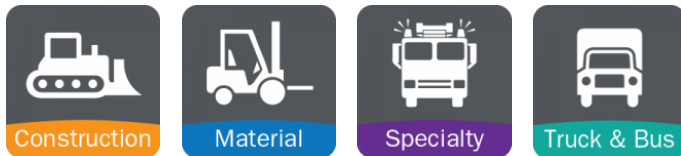

## PRODUCT WARNINGS

---

For California residents:

**⚠ WARNING:** Cancer and reproductive harm - [www.P65Warnings.ca.gov](http://www.P65Warnings.ca.gov).

**⚠ AVERTISSEMENT:** Cancer et effet nocif sur la reproduction - [www.P65Warnings.ca.gov](http://www.P65Warnings.ca.gov).

## SUITS THESE PRODUCTS

---



### **6" x 8" LED Tail Lights**

LED Tail Lights - Model  
279

---

**Print date: 2026-04-03**

© 2026 J.W. Speaker Corporation • Germantown, WI U.S.A.  
[www.jwspeaker.com](http://www.jwspeaker.com) • [speaker@jwspeaker.com](mailto:speaker@jwspeaker.com) • 262.251.6660