

LED License Plate Light - Model 125

PRODUCT INFORMATION

Description	12-24V ECE/SAE LED License Plate Light
Height	61.21 mm / 2.41 in
Width	114.30 mm / 4.5 in
Depth	60.71 mm / 2.39 in
Shape	Stylized
Outer Lens Material	Polycarbonate
Outer Lens Color	Clear
Housing Material	Polycarbonate
Housing Color	Black
Mounting Hardware Description	(x2) M5-0.8 x 30mm Mounting Bolts
Mounting Type	Universal Mount
Minimum Operating Temperature	-40 °C / -40 °F
Maximum Operating Temperature	65 °C / 149 °F
Connector or Wiring	6" Bare Leads
Product Weight	0.38 lbs / 0.17 kgs
Shipping Weight	2.30 lbs / 1.04 kgs



PRODUCT DIMENSIONS

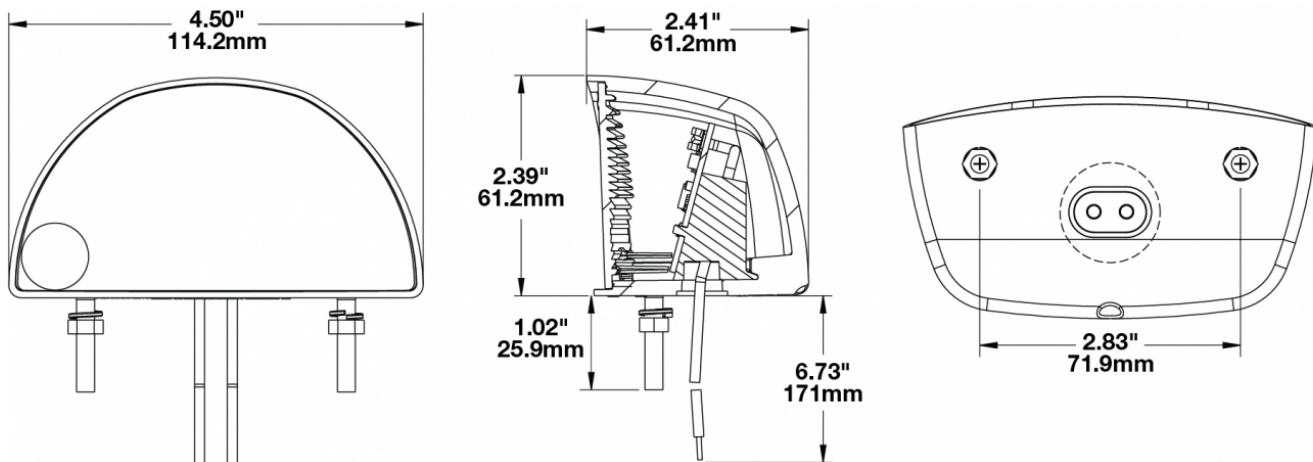

Print date: 2026-06-21

© 2026 J.W. Speaker Corporation • Germantown, WI U.S.A.
 www.jwspeaker.com • speaker@jwspeaker.com • 262.251.6660

J.W. SPEAKER
 Engineered. Lighting. Solutions.

LED License Plate Light - Model 125

ELECTRICAL SPECIFICATIONS

Input Voltage	12-24V DC
(2) Yellow Wire	Not Polarity
Current Draw	0.23 (Max)A @ 12V DC

REGULATORY STANDARDS COMPLIANCE



Buy America Standards	ECE Reg 4
ECE Reg 50	Eco Friendly
IEC IP67	SAE J587

PHOTOMETRIC SPECIFICATIONS

Nominal LED Color Temperature	5000 K
Beam Pattern(s)	Signalization - License Plate Illuminator

APPLICATIONS



PRODUCT WARNINGS

For California residents:

⚠ **WARNING:** Cancer and reproductive harm - www.P65Warnings.ca.gov.

⚠ **AVERTISSEMENT:** Cancer et effet nocif sur la reproduction - www.P65Warnings.ca.gov.

Print date: 2026-06-21

© 2026 J.W. Speaker Corporation • Germantown, WI U.S.A.
www.jwspeaker.com • speaker@jwspeaker.com • 262.251.6660

J.W. SPEAKER
Engineered. Lighting. Solutions.