

LED Off road Light - Model TS3001V

PRODUCT INFORMATION

Description	12-24V DOT LED Auxiliary Light with Driving Beam - 1 Light
Height	150.00 mm / 5.91 in
Width	184.00 mm / 7.24 in
Depth	104.00 mm / 4.09 in
Shape	Oval
Outer Lens Material	Polycarbonate
Outer Lens Color	Clear
Housing Material	Xenoy
Housing Color	Black
Mounting Hardware Description	(x1) 3/8-16 x 1.5" Stainless Steel Screws
Mounting Type	Bracket
Connector or Wiring	Integral Deutsch DT04-2P
Mating Connector	DT06-2S
Product Weight	2.01 lbs / 0.91 kgs
Shipping Weight	2.01 lbs / 0.91 kgs



PRODUCT DIMENSIONS

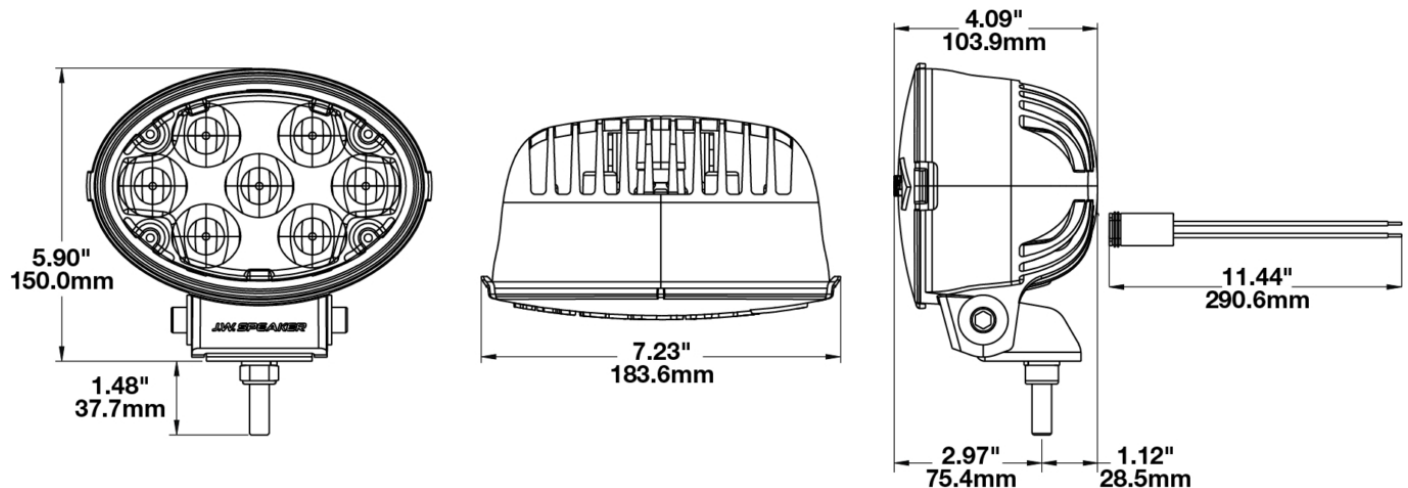

Print date: 2026-05-14

© 2026 J.W. Speaker Corporation • Germantown, WI U.S.A.
 www.jwspeaker.com • speaker@jwspeaker.com • 262.251.6660

J.W. SPEAKER
 Engineered. Lighting. Solutions.

LED Off road Light - Model TS3001V

ELECTRICAL SPECIFICATIONS

Input Voltage	12-24V DC
Operating Voltage	9-32V DC
Red Wire	Power
Black Wire	Ground
Current Draw	1.90A @ 12V DC 1.05A @ 24V DC

REGULATORY STANDARDS COMPLIANCE

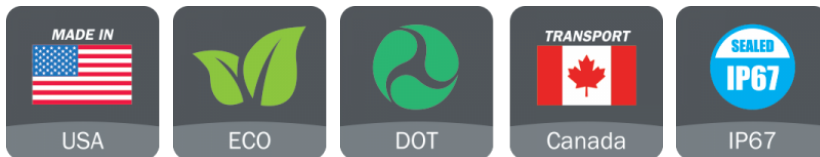

Buy America Standards Eco Friendly
 FMVSS 108 s10.1 (Table XVIII) IEC IP67

PHOTOMETRIC SPECIFICATIONS

Raw Lumen Output	1,960
Effective Lumen Output	1,080
Candela Output	55,000
Beam Pattern(s)	Forward Lighting - Driving

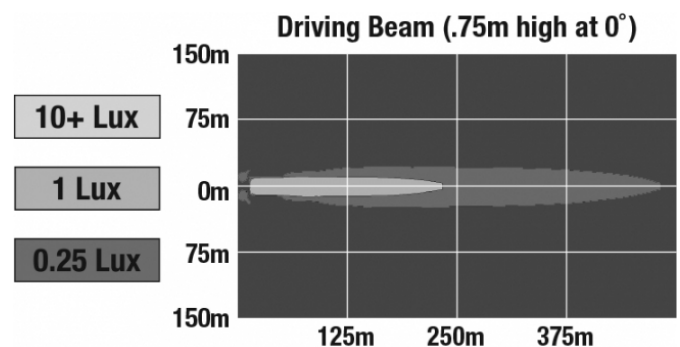

Print date: 2026-05-14

© 2026 J.W. Speaker Corporation • Germantown, WI U.S.A.
 www.jwspeaker.com • speaker@jwspeaker.com • 262.251.6660

LED Off road Light - Model TS3001V

APPLICATIONS

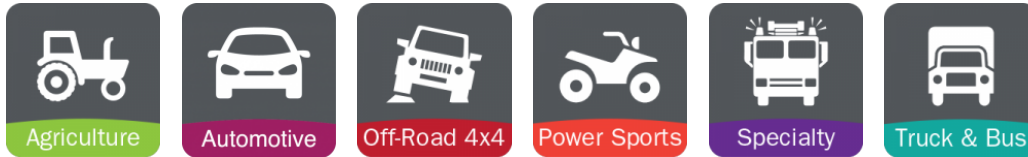

PRODUCT WARNINGS

For California residents:

⚠ **WARNING:** Cancer and reproductive harm - www.P65Warnings.ca.gov.

⚠ **AVERTISSEMENT:** Cancer et effet nocif sur la reproduction - www.P65Warnings.ca.gov.

ACCESSORIES



Part Number
5865951
Black Replacement
Lens Cover for Model
TS3001V



Part Number
5874231
Clear Replacement
Lens Cover for Model
TS3001V



Part Number
5874241
Red Replacement Lens
Cover for Model
TS3001V



Part Number
5874251
Amber Replacement
Lens Cover for Model
TS3001V



Part Number
5874261
Blue Replacement
Lens Cover for Model
TS3001V



Part Number
6149203
A-Pillar Mounting Kit
for Jeep JK



Part Number
6149233
A-Pillar Mounting Kit
for Jeep TJ

Print date: 2026-05-14

© 2026 J.W. Speaker Corporation • Germantown, WI U.S.A.
www.jwspeaker.com • speaker@jwspeaker.com • 262.251.6660

J.W. SPEAKER
Engineered. Lighting. Solutions.

LED Off road Light - Model TS3001V

RELATED PRODUCTS



Part Number
0550673
12-24V DOT LED
Auxiliary Light with
Driving Beam - 2 Light
Kit



Part Number
0550691
12-24V ECE LED
Auxiliary Light with
Driving Beam - 1 Light



Part Number
0550693
12-24V ECE LED
Auxiliary Light with
Driving Beam - 2 Light
Kit



Part Number
0550711
12-24V LED Auxiliary
Light with Pencil Beam
- 1 Light



Part Number
0550713
12-24V LED Auxiliary
Light with Pencil Beam
- 2 Light Kit