

LED Tail Lights - Model 279 J Series

PRODUCT INFORMATION

Description	12-24V DOT LED Jeep Tail Light Kit - 2 Light Kit
Height	210.31 mm / 8.28 in
Width	153.67 mm / 6.05 in
Depth	87.12 mm / 3.43 in
Shape	Rectangular
Outer Lens Material	Acrylic
Outer Lens Color	Clear
Housing Material	Polycarbonate
Housing Color	Black
Bezel Color	Black
Mounting Hardware Description	(x4) #8-16 x 2 Pan Head, Self Tapping Plastite Screw
Connector or Wiring	YAZAKI 7287-2779-30
Mating Connector	YAZAKI 7282-5553-30
Product Weight	6.40 lbs / 2.9 kgs
Shipping Weight	5.80 lbs / 2.63 kgs



PRODUCT DIMENSIONS

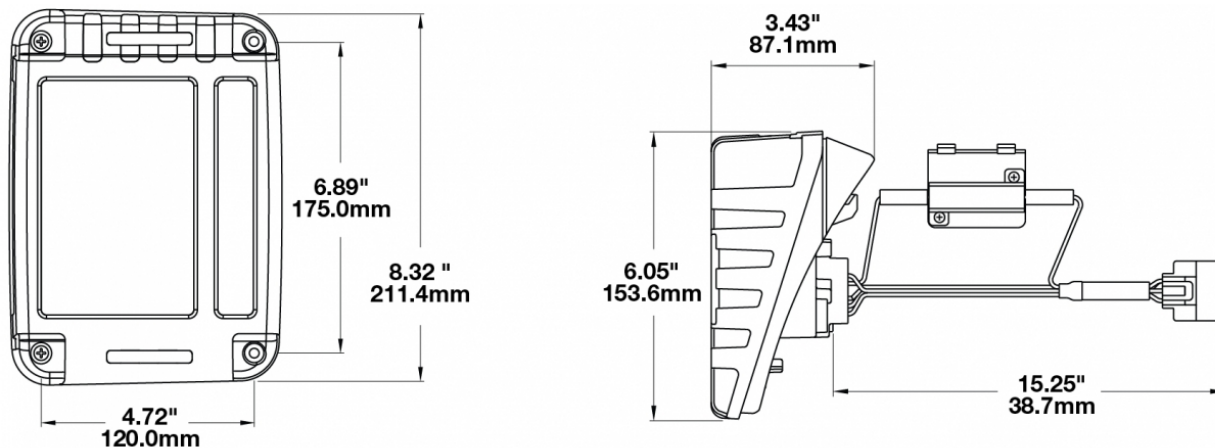

Print date: 2026-06-02

© 2026 J.W. Speaker Corporation • Germantown, WI U.S.A.
 www.jwspeaker.com • speaker@jwspeaker.com • 262.251.6660

J.W. SPEAKER
 Engineered. Lighting. Solutions.

LED Tail Lights - Model 279 J Series

ELECTRICAL SPECIFICATIONS

Input Voltage	12-24V DC
Operating Voltage	9-32V DC
Transient Spike Protection	150V Peak @ 1 HZ-100 Pulses
Black Wire	Ground
Purple Wire	Tail
Yellow Wire	Stop
Green Wire	Reverse
Current Draw	1.70A @ 12V DC (Stop/Turn) 0.21A @ 24V DC (Stop/Turn) 0.10A @ 12V DC (Tail) 0.09A @ 24V DC (Tail) 0.18A @ 12V DC (Reverse) 0.10A @ 24V DC (Reverse)

REGULATORY STANDARDS COMPLIANCE

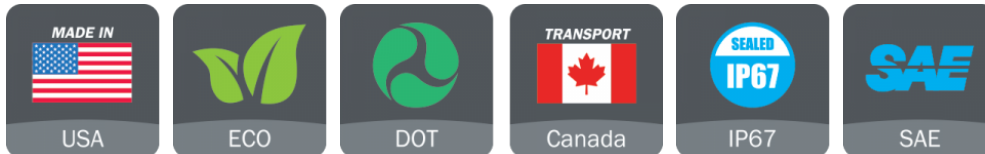

Buy America Standards	Eco Friendly
FMVSS 108 s7.1 (Table VII)	FMVSS 108 s7.2 (Table VIII)
FMVSS 108 s7.3 (Table IX)	FMVSS 108 s7.4 (Table X)
FMVSS 108 s7.6 (Table XII)	FMVSS 108 s8.1 (Table XVI)
IEC IP67	SAE J575
SAE J585	SAE J586
SAE J588	SAE J592
SAE J593	SAE J594

PHOTOMETRIC SPECIFICATIONS

Beam Pattern(s)	Signalization - Stop Signalization - Tail Signalization - Turn (Rear)
------------------------	---

Print date: 2026-06-02

© 2026 J.W. Speaker Corporation • Germantown, WI U.S.A.
www.jwspeaker.com • speaker@jwspeaker.com • 262.251.6660

LED Tail Lights - Model 279 J Series

APPLICATIONS



WARRANTY

Check with your dealer to make sure they can be returned in the event your lights do not function properly.

Hyper-flashing is not warrantable. Read about what causes hyper-flashing and what you can do if you experience it with your LED upgrade on our website at www.jwspeaker.com/hyper-flashing

PRODUCT WARNINGS

For California residents:

⚠ **WARNING:** Cancer and reproductive harm - www.P65Warnings.ca.gov.

⚠ **AVERTISSEMENT:** Cancer et effet nocif sur la reproduction - www.P65Warnings.ca.gov.