

# LED Tail Lights - Model 279 J Series

## PRODUCT INFORMATION

<b>Description</b>	12-24V DOT LED Jeep Tail Light Kit - 2 Light Kit
<b>Height</b>	210.31 mm / 8.28 in
<b>Width</b>	153.67 mm / 6.05 in
<b>Depth</b>	87.12 mm / 3.43 in
<b>Shape</b>	Rectangular
<b>Outer Lens Material</b>	Acrylic
<b>Outer Lens Color</b>	Clear
<b>Housing Material</b>	Polycarbonate
<b>Housing Color</b>	Black
<b>Bezel Color</b>	Black
<b>Mounting Hardware Description</b>	(x4) #8-16 x 2 Pan Head, Self Tapping Plastite Screw
<b>Connector or Wiring</b>	YAZAKI 7287-2779-30
<b>Mating Connector</b>	YAZAKI 7282-5553-30
<b>Product Weight</b>	6.40 lbs / 2.9 kgs
<b>Shipping Weight</b>	5.80 lbs / 2.63 kgs



## PRODUCT DIMENSIONS

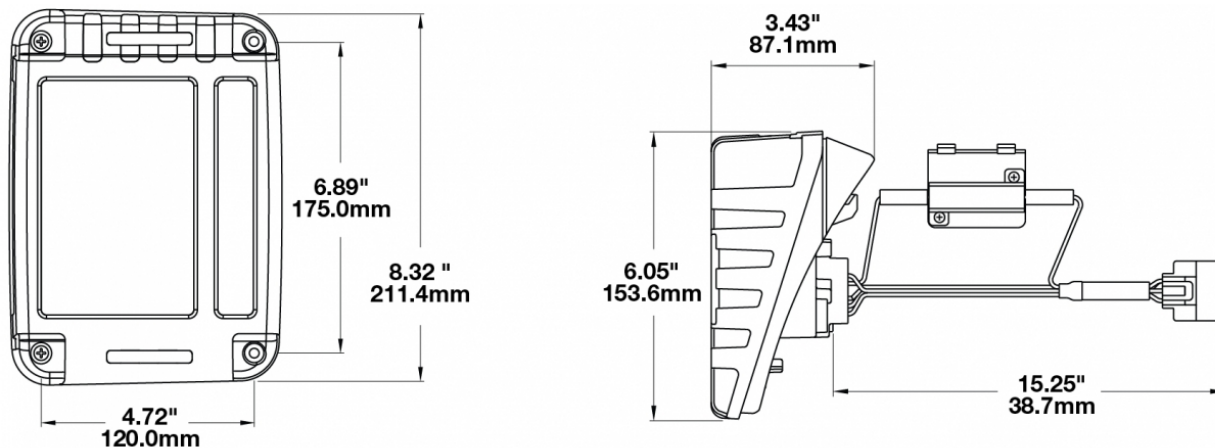

Print date: 2026-05-06

© 2026 J.W. Speaker Corporation • Germantown, WI U.S.A.  
 www.jwspeaker.com • speaker@jwspeaker.com • 262.251.6660

**J.W. SPEAKER**  
 Engineered. Lighting. Solutions.

# LED Tail Lights - Model 279 J Series

## ELECTRICAL SPECIFICATIONS

<b>Input Voltage</b>	12-24V DC
<b>Operating Voltage</b>	9-32V DC
<b>Transient Spike Protection</b>	150V Peak @ 1 HZ-100 Pulses
<b>Black Wire</b>	Ground
<b>Purple Wire</b>	Tail
<b>Yellow Wire</b>	Stop
<b>Green Wire</b>	Reverse
<b>Current Draw</b>	1.70A @ 12V DC (Stop/Turn) 0.21A @ 24V DC (Stop/Turn) 0.10A @ 12V DC (Tail) 0.09A @ 24V DC (Tail) 0.18A @ 12V DC (Reverse) 0.10A @ 24V DC (Reverse)

## REGULATORY STANDARDS COMPLIANCE

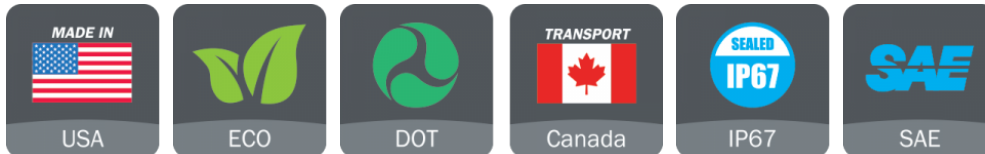

Buy America Standards	Eco Friendly
FMVSS 108 s7.1 (Table VII)	FMVSS 108 s7.2 (Table VIII)
FMVSS 108 s7.3 (Table IX)	FMVSS 108 s7.4 (Table X)
FMVSS 108 s7.6 (Table XII)	FMVSS 108 s8.1 (Table XVI)
IEC IP67	SAE J575
SAE J585	SAE J586
SAE J588	SAE J592
SAE J593	SAE J594

## PHOTOMETRIC SPECIFICATIONS

<b>Beam Pattern(s)</b>	Signalization - Stop Signalization - Tail Signalization - Turn (Rear)
------------------------	---

Print date: 2026-05-06

© 2026 J.W. Speaker Corporation • Germantown, WI U.S.A.  
www.jwspeaker.com • speaker@jwspeaker.com • 262.251.6660

# LED Tail Lights - Model 279 J Series

## APPLICATIONS

---



## WARRANTY

---

Check with your dealer to make sure they can be returned in the event your lights do not function properly.

Hyper-flashing is not warrantable. Read about what causes hyper-flashing and what you can do if you experience it with your LED upgrade on our website at [www.jwspeaker.com/hyper-flashing](http://www.jwspeaker.com/hyper-flashing)

## PRODUCT WARNINGS

---

For California residents:

⚠ **WARNING:** Cancer and reproductive harm - [www.P65Warnings.ca.gov](http://www.P65Warnings.ca.gov).

⚠ **AVERTISSEMENT:** Cancer et effet nocif sur la reproduction - [www.P65Warnings.ca.gov](http://www.P65Warnings.ca.gov).