

Jeep LED Headlights - Model EVO J3

PRODUCT INFORMATION

Description	12V DOT LED High/Low Beam Heated Headlight w/ Built In Turn Signal - Graphite - 2 Light Kit
Height	176.50 mm / 6.95 in
Width	176.50 mm / 6.95 in
Depth	112.00 mm / 4.41 in
Shape	Round
Outer Lens Material	Polycarbonate
Outer Lens Color	Clear
Housing Material	Aluminum
Housing Color	Black
Bezel Color	Grey
Retrofits	7" Round Headlights or 2D1 PAR56
Minimum Operating Temperature	-40 °C / -40 °F
Maximum Operating Temperature	65 °C / 149 °F
Connector or Wiring	H13 Delphi 15326813
Product Weight	5.10 lbs / 2.31 kgs
Shipping Weight	5.90 lbs / 2.68 kgs

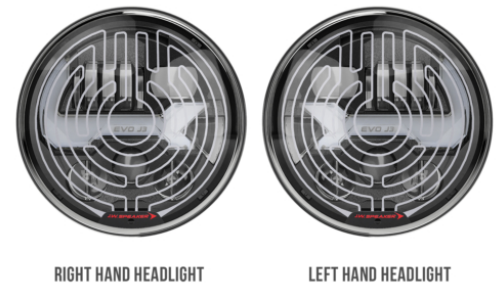

EVO J3™

PRODUCT DIMENSIONS

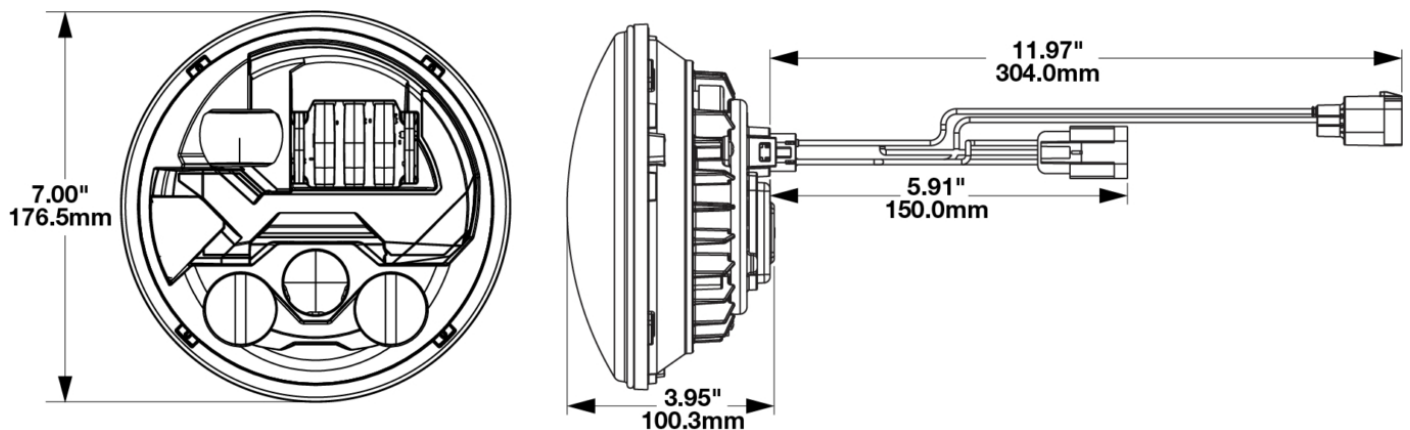

Print date: 2026-06-18

© 2026 J.W. Speaker Corporation • Germantown, WI U.S.A.
www.jwspeaker.com • speaker@jwspeaker.com • 262.251.6660

J.W. SPEAKER®
Engineered. Lighting. Solutions.

Jeep LED Headlights - Model EVO J3

ELECTRICAL SPECIFICATIONS

Input Voltage	12V DC
Operating Voltage	9-16V DC
Transient Spike Protection	150V Peak @ 1 HZ-100 Pulses
Black Wire	Ground
Yellow Wire	Low Beam
White Wire	High Beam
Orange Wire	Front Turn
Red Wire	Position
Current Draw	2.33A @ 12V DC (Low Beam) 3.25A @ 12V DC (High Beam) 3.00A @ 12V DC (Front Turn) 0.45A @ 12V DC (Position)

REGULATORY STANDARDS COMPLIANCE



Bluetooth SIG Declaration ID	Buy America Standards
Eco Friendly	FMVSS 108 s10.1 (Table XIX)
FMVSS 108 s10.1 (Table XVIII)	FMVSS 108 s7.1 (Table VI)
IEC IP69K	

Print date: 2026-06-18

© 2026 J.W. Speaker Corporation • Germantown, WI U.S.A.
www.jwspeaker.com • speaker@jwspeaker.com • 262.251.6660

J.W. SPEAKER 
Engineered. Lighting. Solutions.

Jeep LED Headlights - Model EVO J3

PHOTOMETRIC SPECIFICATIONS

Raw Lumen Output	3,600 (High Beam); 3,020 (Low Beam)
Effective Lumen Output	1,320 (High Beam); 1,201 (Low Beam)
Candela Output	68,800 (High Beam) 24,800 (Low Beam)
Nominal LED Color Temperature	5000 K
Beam Pattern(s)	Forward Lighting - High Beam (DOT) Forward Lighting - Low Beam (DOT) Signalization - Front Position Signalization - Turn (Front)



APPLICATIONS



PRODUCT WARNINGS

For California residents:

⚠ **WARNING:** Cancer and reproductive harm - www.P65Warnings.ca.gov.

⚠ **AVERTISSEMENT:** Cancer et effet nocif sur la reproduction - www.P65Warnings.ca.gov.

Print date: 2026-06-18

© 2026 J.W. Speaker Corporation • Germantown, WI U.S.A.
www.jwspeaker.com • speaker@jwspeaker.com • 262.251.6660

J.W. SPEAKER
Engineered. Lighting. Solutions.

Jeep LED Headlights - Model EVO J3

RELATED PRODUCTS



Part Number
0555593
12V DOT LED
High/Low Beam
Headlight w/ Built In
Turn Signal - Graphite
- 2 Light Kit



Part Number
0556441
12V DOT LED
High/Low Beam
Headlight w/ Built In
Turn Signal - Graphite
- Single RH Light



Part Number
0556451
12V DOT LED
High/Low Beam
Headlight w/ Built In
Turn Signal - Graphite
- Single LH Light



Part Number
0556461
12V DOT LED
High/Low Beam
Heated Headlight w/
Built In Turn Signal -
Graphite - Single RH
Light



Part Number
0556471
12V DOT LED
High/Low Beam
Heated Headlight w/
Built In Turn Signal -
Graphite - Single LH
Light



Part Number
0557193
12V DOT LED
High/Low Beam
Headlight w/ Built In
Turn Signal - Black - 2
Light Kit



Part Number
0557213
12V DOT LED
High/Low Beam
Heated Headlight w/
Built In Turn Signal -
Black - 2 Light Kit



Part Number
0557251
12V DOT LED
High/Low Beam
Headlight w/ Built In
Turn Signal - Black -
Single RH Light