

Wire Harness for 7" Motorcycle Headlights

PRODUCT INFORMATION

Description	Wire Harness for 7" Motorcycle Headlights
Mounting Hardware Description	(x4) Solder Butt Connectors
Connector or Wiring	Packard Wire Adapter
Mating Connector	H4
Shipping Weight	5.00 lbs / 2.27 kgs



PRODUCT DIMENSIONS

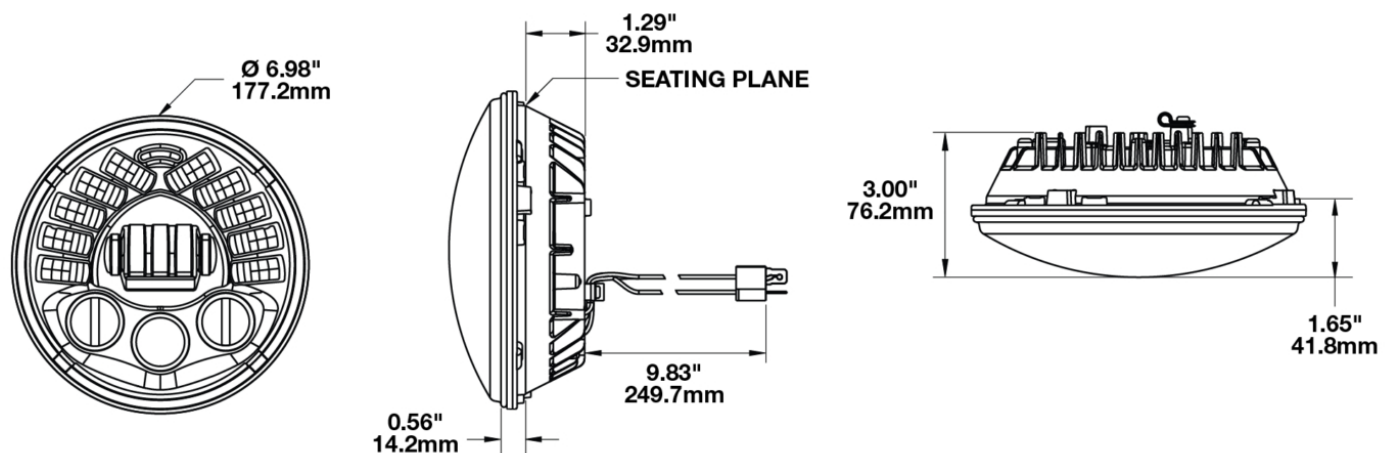

Print date: 2026-05-29

© 2026 J.W. Speaker Corporation • Germantown, WI U.S.A.
 www.jwspeaker.com • speaker@jwspeaker.com • 262.251.6660

Wire Harness for 7" Motorcycle Headlights

REGULATORY STANDARDS COMPLIANCE



Buy America Standards

Eco Friendly

APPLICATIONS

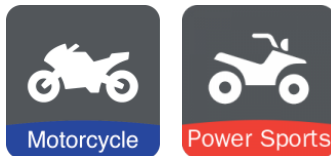

ADDITIONAL INFORMATION

This wire adapter is intended to be used on 2014 and newer Harley Davidson® touring bikes.

This is wire harness that includes an H4 to Packard wire adapter, as well as 4 sealed solder butt connectors, depending on your bike's configuration.

To find out if this adapter is necessary for installation, check out the "7" Round Motorcycle Headlight Fitment Guide" available online at www.jwspeaker.com/resources

PRODUCT WARNINGS

For California residents:

⚠ WARNING: Cancer and reproductive harm - www.P65Warnings.ca.gov.

⚠ AVERTISSEMENT: Cancer et effet nocif sur la reproduction - www.P65Warnings.ca.gov.

Print date: 2026-05-29

© 2026 J.W. Speaker Corporation • Germantown, WI U.S.A.
www.jwspeaker.com • speaker@jwspeaker.com • 262.251.6660

J.W. SPEAKER 
Engineered. Lighting. Solutions.

Wire Harness for 7" Motorcycle Headlights

SUITS THESE PRODUCTS



7" Round LED Motorcycle Headlights

7" Round LED
Motorcycle Headlights
- Model 8790 Adaptive
2