

Adaptive LED Headlights – Model 8691 Adaptive 2

PRODUCT INFORMATION

Description	12V DOT/ECE LED High and Low Beam Adaptive Headlight with Black Inner Bezel
Height	143.00 mm / 5.63 in
Width	143.00 mm / 5.63 in
Depth	82.50 mm / 3.25 in
Shape	Round
Outer Lens Material	Polycarbonate
Outer Lens Color	Clear
Housing Material	Aluminum
Housing Color	Grey
Bezel Color	Black
Retrofits	Pedestal 5 3/4" Round Headlights (PAR46)
Minimum Operating Temperature	-40 °C / -40 °F
Maximum Operating Temperature	65 °C / 149 °F
Connector or Wiring	Bare Leads
Product Weight	3.08 lbs / 1.4 kgs
Shipping Weight	2.99 lbs / 1.36 kgs



Print date: 2026-04-13

© 2026 J.W. Speaker Corporation • Germantown, WI U.S.A.
www.jwspeaker.com • speaker@jwspeaker.com • 262.251.6660

J.W. SPEAKER 
Engineered. Lighting. Solutions.

Adaptive LED Headlights – Model 8691 Adaptive 2

PRODUCT DIMENSIONS

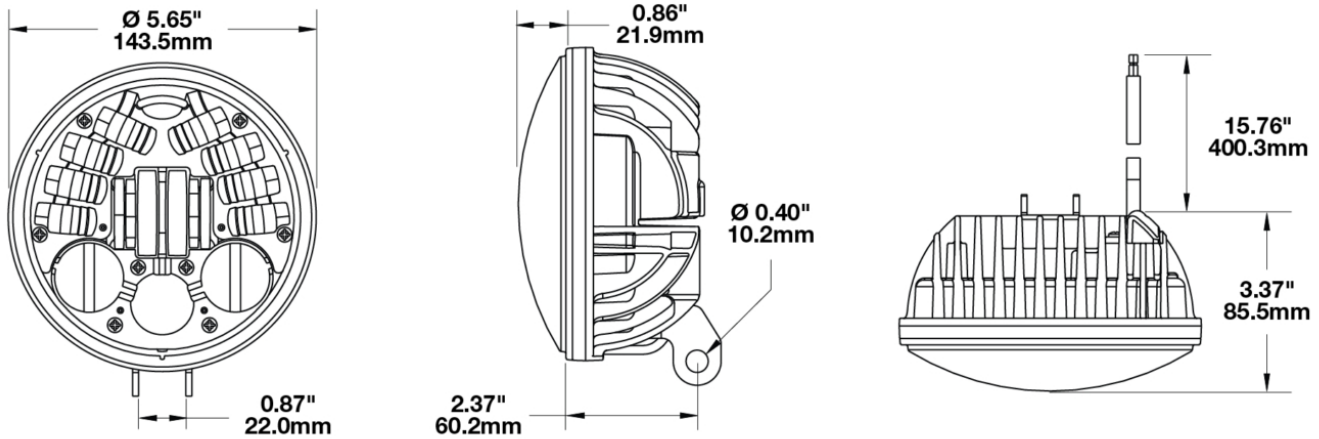

ELECTRICAL SPECIFICATIONS

Input Voltage	12V DC
Operating Voltage	9-16V DC
Transient Spike Protection	150V Peak @ 1 HZ-100 Pulses
Black Wire	Ground
White Wire	High Beam
Yellow Wire	Low Beam
Red Wire	Front Position
Current Draw	1.9A @ 12V DC (Low Beam) 3.2A @ 12V DC (High Beam) 0.21A @ 12V DC (Front Position) 4.2A @ 12V DC (Low Beam at Full Lean) 5.5A @ 12V DC (High Beam at Full Lean)

Print date: 2026-04-13

© 2026 J.W. Speaker Corporation • Germantown, WI U.S.A.
www.jwspeaker.com • speaker@jwspeaker.com • 262.251.6660

Adaptive LED Headlights – Model 8691 Adaptive 2

REGULATORY STANDARDS COMPLIANCE



Buy America Standards	ECE Reg 113
ECE Reg 50	Eco Friendly
FMVSS 108 s10.1 (Table XX)	IEC IP67

PHOTOMETRIC SPECIFICATIONS

Raw Lumen Output	3,520 (High Beam); 2,120 (Low Beam)
Effective Lumen Output	1,600 (High Beam); 1,050 (Low Beam)
Candela Output	60,000 (High Beam); 8,300 (Low Beam)
Nominal LED Color Temperature	5000 K
Beam Pattern(s)	Forward Lighting - High Beam (DOT/ECE) Forward Lighting - Low Beam (DOT/ECE) Signalization - Front Position

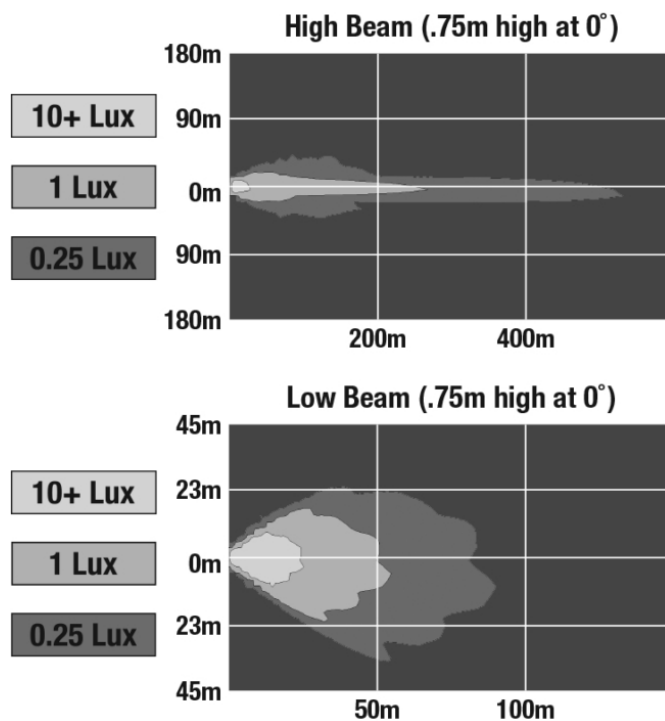

Print date: 2026-04-13

© 2026 J.W. Speaker Corporation • Germantown, WI U.S.A.
www.jwspeaker.com • speaker@jwspeaker.com • 262.251.6660

Adaptive LED Headlights – Model 8691 Adaptive 2

APPLICATIONS



ADDITIONAL INFORMATION

Improvements over the original Adaptive Series

The NEW Adaptive 2 Series headlights have been improved to feature Adaptive technology when using the high beam, in addition to the low beam. Providing ditch-to-ditch lighting to eliminate dark corners on sharp turns and a punch of light 1,500 feet down the road to give you a safer and more confident ride.

Red Wire

Note about Front Position: The front position light is a requirement outside the United States. **If your bike is operated in the United States you do NOT need to connect this wire (red)** unless your bike is equipped with a front position light.

PRODUCT WARNINGS

For California residents:

▲ **WARNING:** Cancer and reproductive harm - www.P65Warnings.ca.gov.

▲ **AVERTISSEMENT:** Cancer et effet nocif sur la reproduction - www.P65Warnings.ca.gov.

RELATED PRODUCTS



Part Number

0555121

12V DOT/ECE LED
High and Low Beam
Adaptive Headlight
with Chrome Inner
Bezel

Print date: 2026-04-13

© 2026 J.W. Speaker Corporation • Germantown, WI U.S.A.
www.jwspeaker.com • speaker@jwspeaker.com • 262.251.6660

J.W. SPEAKER 
Engineered. Lighting. Solutions.